

Westclox BIG BEN and BABY BEN Identification Guide

By Richard Tjarks and Bill Stoddard

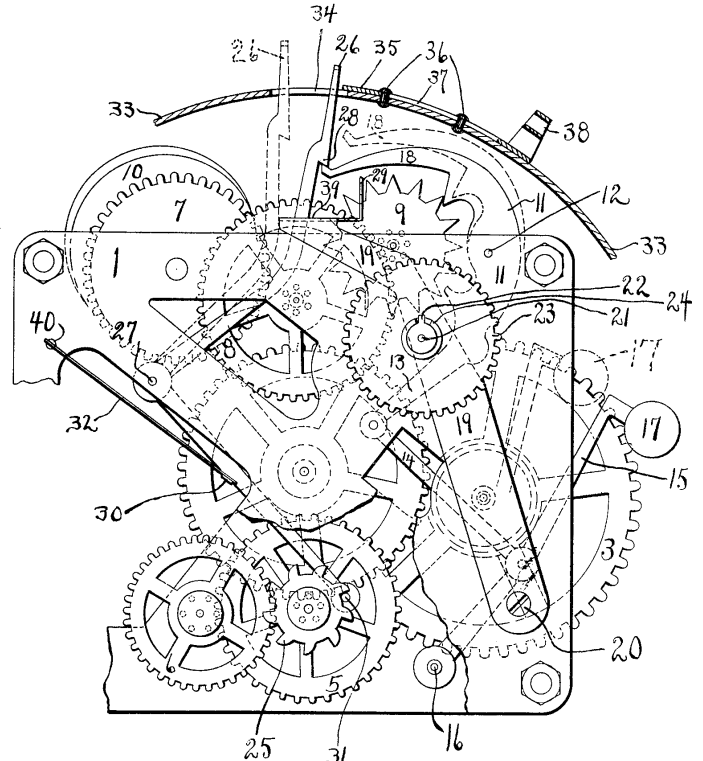
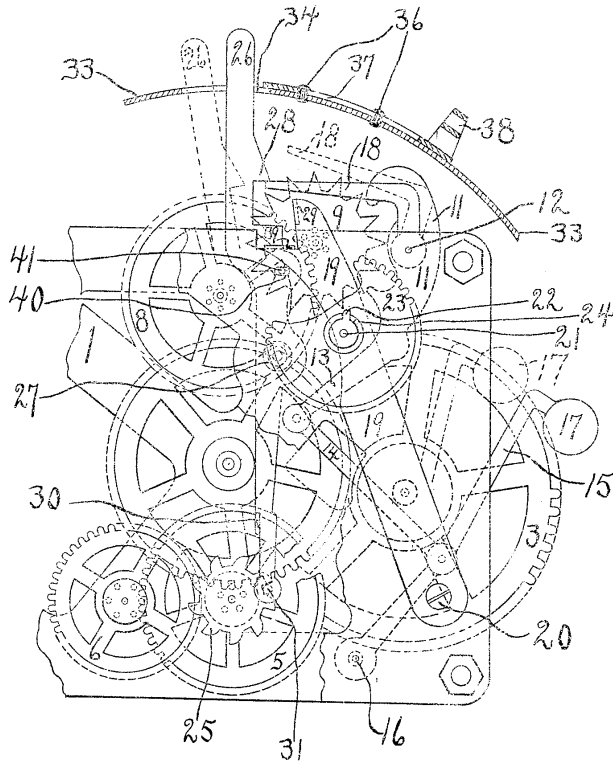
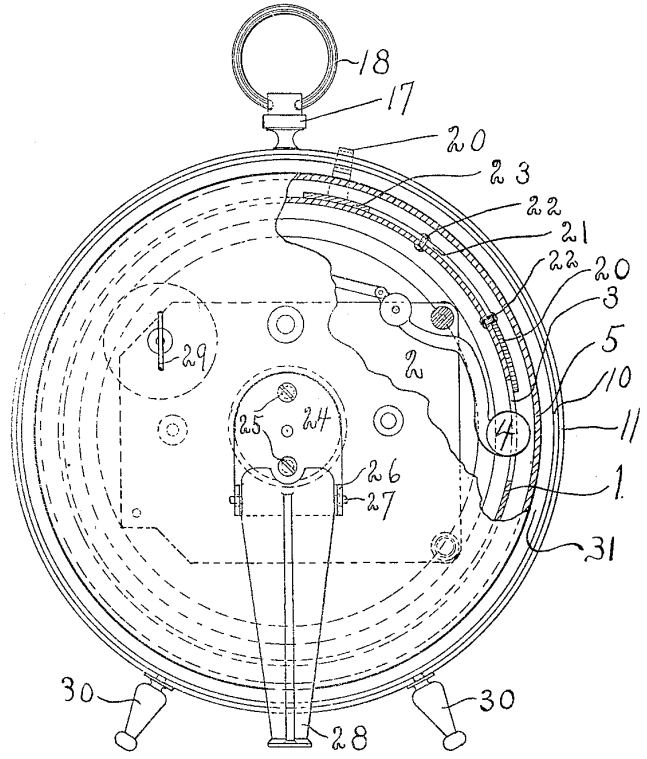
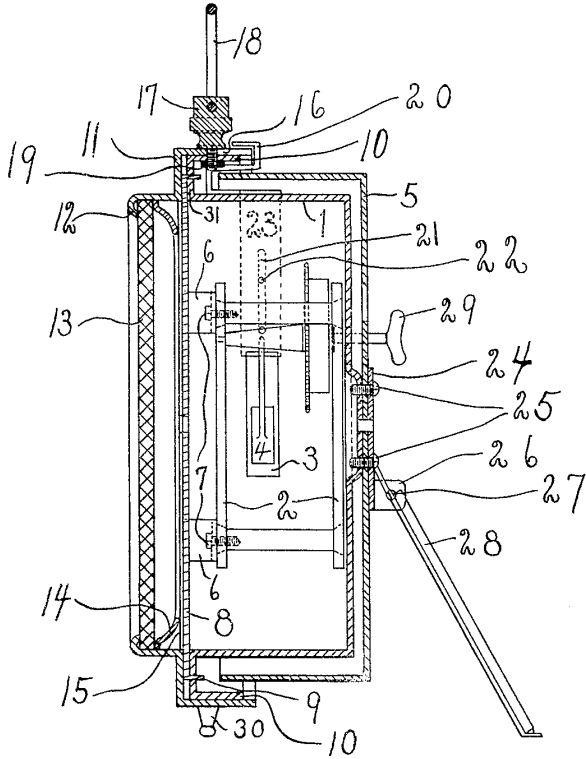

PREFACE

The Westclox Big Ben and Baby Ben are the best-known alarm clocks ever produced. The first Big Ben alarm clocks were sold in 1909, and they were first nationally advertised in the Sept. 24, 1910 *Saturday Evening Post*. The Baby Ben was first marketed in 1910, and first nationally advertised in the Sept. 25, 1915 *Saturday Evening Post*. Big Ben and Baby Ben retailed for \$2.50 until 1918.

Big Ben and Baby Ben have been in continuous production, except during World War II. Nine case styles for windup Bens were made in the USA (and several other countries), and a “style 10” is currently in production in China. A summary of the case styles is given, then two charts present these styles and their production dates in concise form. The body of this article gives a history of Big Ben and Baby Ben wind-up alarm clocks, followed by information about electric Big Bens and Baby Bens. Clocks closely related to the Big and Baby Bens are then discussed, followed by details about reproductions of the Bens.

This article started out as a 12 page booklet which was distributed free of charge at the 1984 NAWCC National Convention in Indianapolis, in conjunction with the Westclox display. An updated version was published in the Alarm Clock Chapter Newsletter in 2005, volumes 1 and 2.

I dedicate this edition to the memory of my friend and colleague Richard C. Tjarks, 1950 – 2005.

ABOUT THE COVER

The upper two drawings are from patent number 890,066, issued to George Kern on June 9, 1908. This is the first patent pertaining to Big Ben. It gives the basic idea of the bell-back case, where the bell is an integral part of the case and not simply an add-on. No examples of this clock are presently known. The movement is like that of the “America” alarm clock, with a different hammer. Note the folding rear leg.

The lower left drawing is from the first Big Ben movement patent, #904,333 issued to George Kern on Nov. 17, 1908. The lower right drawing is from the second Big Ben movement patent, #958,930, issued to George Kern on May 24, 1910. Note the changes to the repeat lever, part 26.

COMMENTS AND CORRECTIONS

Please send any comments, corrections and suggestions to Bill Stoddard at:

Bill's Clockworks
8 W. Columbia Street
Flora, IN 46929

E-mail: bill@billsclockworks.com

For updates to this ID Guide and more Westclox information,
check my Clock History web site at
<http://ClockHistory.com/westclox/>

William S. Stoddard
January 15, 2012

Westclox
BIG BEN and BABY BEN
Identification Guide

Richard Tjarks and Bill Stoddard

Table of Contents

PREFACE.....	2
IDENTIFYING BIG BEN AND BABY BEN ALARM CLOCKS.....	4
MOVEMENT DATE STAMPS.....	6
CHART 1 BABY BEN IDENTIFICATION.....	7
CHART 2 BIG BEN IDENTIFICATION.....	8
BIG BEN MOVEMENTS.....	9
BIG BEN STYLE 1.....	12
BIG BEN ADVERTISING AND PROMOTION.....	13
BIG BEN STYLE 1A.....	16
STYLE 2 BIG BEN AND BABY BEN.....	23
STYLE 3 BIG BEN AND BABY BEN.....	24
STYLE 4 BIG BEN AND BABY BEN.....	25
DIFFERENTIATING STYLE 4 FROM STYLE 5 DIALS.....	26
STYLE 5 BIG BEN AND BABY BEN.....	27
STYLE 6 BIG BEN AND BABY BEN.....	29
STYLE 7 BIG BEN AND BABY BEN.....	30
CLOCK OF TOMORROW.....	31
STYLE 8 BIG BEN AND BABY BEN.....	32
STYLE 9 BIG BEN AND BABY BEN.....	33
STYLE 10 BIG BEN AND BABY BEN.....	33
ELECTRIC BIG BENS AND BABY BENS.....	34
OTHER BIG BEN AND BABY BEN MODELS.....	37
MODELS RELATED TO THE BIG BEN.....	38
MODELS RELATED TO THE BABY BEN.....	38
REPRODUCTION MODELS OF BIG BEN AND BABY BEN.....	40
WESTCLOX PATENTS FOR SPRING DRIVEN CLOCKS.....	42
WESTCLOX DESIGN PATENTS FOR BIG AND BABY BEN AND RELATED CLOCKS.....	45
ACKNOWLEDGEMENTS.....	46

IDENTIFYING BIG BEN AND BABY BEN ALARM CLOCKS

Big Ben alarm clocks were first sold in 1909, and first nationally advertised in the September 24, 1910 *Saturday Evening Post*. The leg model or “style 1” was the first model made. Periodically, the case styling was updated to keep up with the times. Ten case styles have been identified that categorize the majority of Big Bens.

The Baby Ben was first marketed in 1910, but not nationally advertised until 1915. The reason for the five-year delay was the time it took to design a reliable small alarm clock. The first Baby Ben movement had an alarm added to a small time-only movement (the “two-inch” movement), resulting in a two-layer design. This clock is the “Baby Ben Two Inch”. It did not look like a miniature version of Big Ben. It proved unsatisfactory, and a Baby Ben with a new case and a new movement was marketed in 1912. This is the style 1 Baby Ben, looking almost¹ like a Big Ben in miniature. Its first movement was still not reliable, and after three years of improvement, Baby Ben was introduced in the September 25, 1915 *Saturday Evening Post*. As with the Big Ben, the case styles were periodically updated. Ten case styles have been identified that categorize the majority of Baby Bens.

The drawings below show the ten case styles. The “style” refers to the **shape of the case**. These are the 10 original styles in which the key wind (and some electric) Big Ben and Baby Ben alarm clocks were made.

When identifying which case style a clock is, ignore the color of the case and examine its shape. The exact form of the dial is irrelevant at this point. Once you have identified the case style, you can read about it in detail in the text that follows. A summary is given in the charts on pages 7 and 8. The charts give the model numbers on the bottom of the base, which can help in identification.

Loud Alarm and Chime Alarm. Style 4, 5, and 6 Big Bens come in both Loud Alarm and Chime Alarm versions. Loud Alarm clocks use the original type of Big Ben movement with intermittent feature and a loud ring. Chime Alarm was introduced with the style 3 Big Ben (all style 3 Big Bens are Chime Alarm). The Chime Alarm starts out with a slow ding---ding-ding---ding---ding-ding, and changes to a steady ring if the alarm is not shut off soon enough. There were a few style 8 Big Bens made with a chime alarm.

The date of manufacture will be found stamped on the movement of most Big and Baby Bens made up through the 1970’s. The date will be numbers for the month, day and year; or the month and year.

Some additional case styles were used for Big Ben electric clocks. These are shown starting on page 34.

Starting in the late 1990’s, reproductions of styles 2 – 8 have been made (as discussed in detail on pages 40 and 41). There was a reproduction of the style 1a made in 1970 that is considered as collectible as the original, since it was such a good copy. A relatively few quartz movement style 9 clocks were made (in the early days of style 9), and these are considered collectible.

You can identify a reproduction of styles 2 – 8 as follows:

- If it has a battery operated movement (it will have a battery door or compartment on the back), it is a reproduction;
- If it was made in China, it is a reproduction;
- If the back is plastic, it is a reproduction.

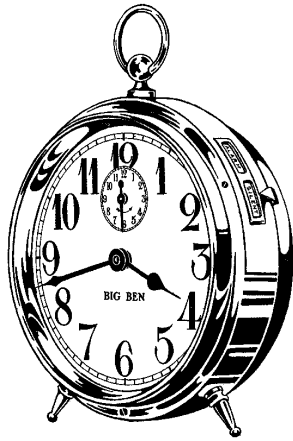

Style 1 and 1a

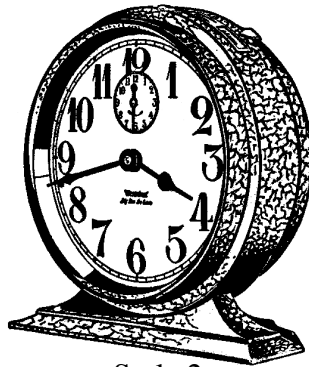

Style 2

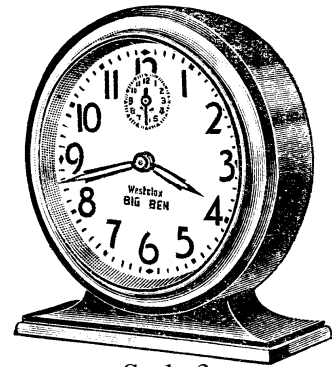

Style 3

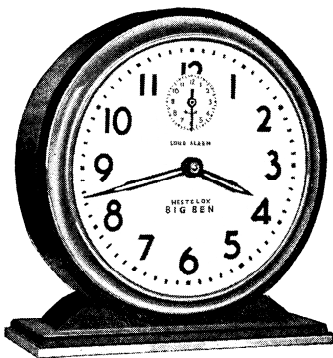

Style 4 and 4a

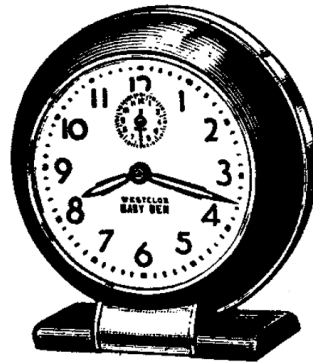

Style 5 and 5a

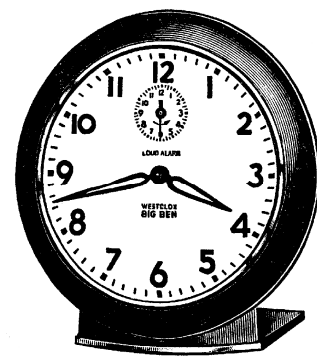

Style 6



Style 7



Style 8



Style 9



Style 10

CASE NOTES

Big Ben style 1 is identified by the three assembly screws through the front, whereas style 1a does not have screws through the front.

Style 2 Big and Baby Ben came in both nickel plated cases and painted cases. The first painted cases were a crackle finish, followed by solid color finishes.

Style 3 has four concave curves on the base, style 4 has two convex curves (one on each side).

Big Ben style 4a Loud Alarm is approximately 1/4 inch deeper than the Big Ben style 4 Chime Alarm

Big Ben style 5a Loud Alarm is approximately 1/4 inch deeper than the Big Ben style 5 Chime Alarm and Big Ben style 5 Loud Alarm. Big Ben style 5 Chime Alarm was made from 1939 – 1949. Big Ben style 4a Loud Alarm was made from 1949 – 1946, followed by the Big Ben style 4 Loud alarm made from 1946 – 1949.

Big Ben and Baby Ben electrics were made in styles 5 and 7.

MOVEMENT DATE STAMPS

Dates were stamped on a movement plate of most Big Ben and Baby Ben clocks. Numbers are used for the month, day and year; or just the month and year (e.g. 5 17 15 is May 17, 1915; and 7 34 is July 1934).

Baby Bens have month, day and year from the beginning through the end of 1928; just the month and year from 1929 through 1932; month, day and year from 1933 through 1944; and then just the month and year again from 1945 on.

Big Ben style 1 clocks have the month, day and year stamped on the movement.

Big Ben style 1a and 2 clocks have month, day and year through 1928; and just month and year from 1929 on.

Big Ben Loud Alarm clocks have the month and year stamped on the movement.

Big Ben Chime Alarm clocks have the month and day up through 1932; month, day and year from 1933 through World War II; and just month and year from WWII through the end of production (1956).

Big Ben single key wind clocks (1956 on) have the month and year stamped on the movement.

CHART 1 BABY BEN IDENTIFICATION

CASE STYLE	MOV'T TYPE	ID	CASE FINISH	DIAL/ NUMERALS	YEARS MADE
Baby Ben Two Inch	2 Inch Two layer	Leg Model, alarm dial at 6:00	Nickel	White/Black	1910 - 1912
1 (thin)	1 1914 1a	Leg Model	Nickel	White/Black	1912 - 1914
1	2 - 1926-27 - 3	Leg Model	Nickel	White/Black Dealer Imprint -- 1920 -- White/Black Black Lum.	1914 - 1930
2	3	“Rd 1927” and/or 61-A	Nickel Old Rose, Blue, Green Crackle -- 1930 -- Butler, Pink Blue, Green	White/Black Black Lum. Gold/Black Gold Lum. 1930 Ivory/Gold	1927 - 1932
3	3a	61-L	Black/Nickel Maroon/Copper Gray/Brass Ivory/Brass	White/Black White/Black Lum.	1932 - 1934
4	3b	61-N	Ivory/Brass Gun M./Nickel	White/Black Brown Band Lum. Black Lum.	1934 - 1939
5	3c	61-R	Ivory/Brass Gun M./Nickel	Ivory/Brown Brown Band Lum. White/Black Black Lum -- 1948 -- Solid Brown Lum.	1939 - 1949
6	3d	61-V	Ivory/Brass Gun M./Nickel	Ivory/Brown Brown Lum. White/Black Black Lum.	1949 - 1956
7	3e - 1960 - 4 ---- 5	61-Y ----- (Plastic base 58056)	White/Brass Black/Nickel Pink or Turquoise Gold or silver	White/Brown Brown Lum. White/Black Black Lum. Metal Finish	1956 – 1964 ----- (ca. 1976)
8	4 ----- 5	53632 -plastic- 58056	White/Brass Black/Nickel Fashion Brite Gold or silver	White/Brown Brown Lum. White/Black Black Lum. Metal Finish Fashion Brite	1964 - 1981
9	6	Plastic bezel			1980 - 2000
10	7	Made in China			Starting in 2001

STANDARD COLOR COMBINATIONS FOR STYLES 4 THROUGH 8 (for both Baby Ben and Big Ben)

Ivory or white cases are trimmed in brass and have ivory or white dials with brown numerals (black numerals for style 4 only) and brown banded or solid brown luminous dials. Gunmetal (metallic black or gray) or black cases are trimmed in nickel (except most style 7 Ben cases are trimmed in brass) and have white dials with black numerals or black luminous dials.

CHART 2 BIG BEN IDENTIFICATION

CASE STYLE	MOV'T TYPE	ID	CASE FINISH	DIAL/ NUMERALS	YEARS MADE
1	1 - 1912 - 2	Leg Model (screws in front)	Nickel	White/Black Plain or Dealer Imprint	1908 - 1918
1a	2	Leg Model (no screws in front)	Nickel	White/Black Dealer Imprint -- 1920 -- White/Black Black Lum.	1918 - 1935
2	2	“Rd 1927” and/or 48-A	Nickel Old Rose, Blue, Green Crackle -- 1930 -- Butler, Pink Blue, Green	White/Black Black Lum. Gold/Black Gold Lum. 1930 Ivory/Gold	1927 - 1932
3 (Chime)	3 3a	69 (concave)	Black/Nickel Butler	White/Black White/Black Lum.	1931 - 1934
4 (Chime)	3a 3b	69 (convex)	Green/Nickel Ivory/Brass Gun M./Nickel	White/Black Brown Band Lum. Black Lum.	1934 - 1939
4a (Loud)	2a	48-D	Gun M./Nickel	White/Black Black Lum.	1935 - 1939
5a (Loud)	2a	S4-D	Gun M./Nickel	White/Black Black Lum.	1939 - 1946
5 (Loud)	2b	69-C	Gun M./Nickel	White/Black Black Lum.	1946 - 1949
5 (Chime)	3b	69-C	Ivory/Brass Gun M./Nickel	Ivory/Brown Brown Band Lum. Brown Lum. White/Black Black Lum.	1939 - 1949
6 (Chime)	3b	48-H	Ivory/Brass Gun M./Nickel	Ivory/Brown Brown Lum. White/Black Black Lum.	1949 - 1956
6 (Loud)	2c	48-H	Gun M./Nickel Ivory/Brass (1954)	White/Black Black Lum. Ivory/Brown Brown Lum.	1949 - 1956
7	4	75-102	White/Brass Black/Nickel Black/Brass Metallic	White/Brown Brown Lum. White/Black Black Lum. Metal Finish	1956 - 1964
8	4 ----- 5	53647 -plastic- 58055	White/Brass Black/Nickel Fashion Brite	White/Brown Brown Lum. White/Black Black Lum. Fashion Brite	1964 - 1981
9	6	Plastic bezel			1979 - 2000

CHART 2 BIG BEN IDENTIFICATION

CASE STYLE	MOV'T TYPE	ID	CASE FINISH	DIAL/ NUMERALS	YEARS MADE
10	7	Made in China			2001

BIG BEN MOVEMENTS

(as referred to in the charts on the previous two pages)

1. Used through mid-1912, this movement does not have removable mainspring bridges.
2. Used from mid 1912 until 1935 in style 1a and 2 clocks. It has removable mainspring bridges.
 - 2a. Rear alarm shutoff knob located near bottom. Used in style 4a and 5a Loud Alarm.
 - 2b. Made thinner in 1946 so the Loud Alarm could use the same case as the Chime Alarm (style 5 case).
- 2c. Alarm shutoff moved to upper rear. Used in style 6 Loud Alarm.
3. Chime Alarm movement introduced in 1931 with “first he whispers, then he shouts” ads. Sliding alarm shutoff. Used in style 3.
 - 3a. Push-pull alarm shutoff knob. Used in later style 3 and early style 4.
 - 3b. Time key positioned further from set knob using gear train. Used in most style 4 and all style 5 and 6. Brass plates were nickel plated until 1951.
4. A full size single key wind movement still using brass plates, introduced in 1956.
5. A much smaller single key wind movement with aluminum plates (same as Baby Ben movement type 5). This movement has variations that need to be documented.
6. Similar to movement type 5 but movement cannot be disassembled for repair. Used in style 9 Big and Baby Ben.
7. Movement made in China. Two key wind (both winding CCW). Used in style 10 Big and Baby Ben.

BABY BEN MOVEMENTS

(as referred to in the charts on the previous two pages)

1. 1912 to mid-1914, this movement has both time and alarm mainsprings in going barrels. CCW alarm wind. Time key has female thread. Flat bridge for time and alarm mainspring.
 - 1a. Transition movement between type 1 and 2. Three examples, dating from 10-31-14 to 12-19-14 have been found so far. Has a narrow winding time barrel, making it as thin as movement 1. Time key has male thread. Flat bridge for time and alarm mainspring.
2. In use from late 1914 or early 1915 until 1926 - 1927, this movement has a going alarm barrel and a winding time barrel. CCW alarm wind. Three dimensional (domed) bridge for time mainspring, flat bridge for alarm mainspring. 1/8” thicker than types 1 and 1a.
3. Introduced 1926 – 1927 and used through the end of the style 2 Baby Ben, this movement has winding barrels for both mainsprings. CW alarm wind. Three dimensional (domed) bridge for time and alarm mainsprings.
 - 3a. Similar to type 3 but has no repeat lever and has rear knob for the alarm shutoff. Used in style 3 Baby Ben and Dura Case clocks.
 - 3b. Used in style 4 Baby Bens, this movement is like type 3a, but has no gear train for the alarm winding mechanism, thus the alarm winding key is positioned lower.

- 3c. Used in style 5 Baby Bens, this movement has a different hammer, and the alarm pull staff is shorter because of the rounded case back.
- 3d. Used in style 6 Baby Ben, has the alarm shutoff knob at the top rear. Brass plates were nickel plated until 1951.
- 3e. Used in style 7 Baby Bens from 1956 – 1960, similar to previous movement but has center alarm indicator.
4. Introduced in 1960, this is a single key wind movement, still using brass plates. Used in style 7 and 8 Baby Bens.
5. Movement with aluminum plates (same as Big Ben movement type 5). This movement has variations that need to be documented.
6. Similar to movement type 5 but movement cannot be disassembled for repair. Used in style 9 Big and Baby Ben.
7. Movement made in China. Two key wind (both winding CCW). Used in style 10 Big and Baby Ben.

The above list does not include the special movements such as Big Ben and Baby Ben Sweep, and the single key wind Chime Alarm movement used in some style 8 Big Bens. There is also a Chinese made single key wind movement being used in the current production style 8 Big Ben and Baby Ben reproductions.

Big Ben

A National Alarm Invented
A.D. 1908 by The Western Clock Co.

SEPTEMBER 24, 1910

\$2.50 THE COPY

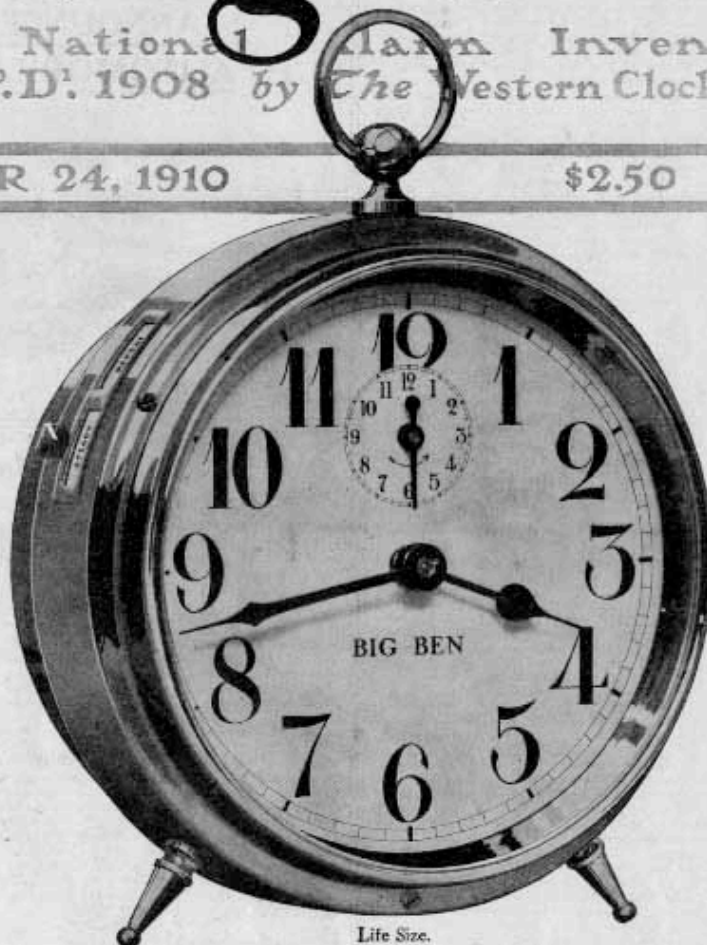

Life Size.

IT IS now two years since Big Ben was first designed by the Western Clock Company, a community of clockmakers founded two generations ago in the little town of La Salle, Illinois.

And with characteristic cautiousness these people have waited two years to put him out, two years of exacting tests and relentless efforts, two years of deliberate and undivided study.

There is no longer room for improvement nor need of secrecy. Big Ben is ready—selected jewelers will receive him

from now on as quickly as consistent with manufacturing care.

Big Ben is a thin, beautiful and punctual sleepmeter with a silent motor that will not annoy you on your lie-awake nights and a deep musical voice that will call you on your sleepest mornings.

Big Ben is mounted in a heavy, triple plated case, with large, strong, easy winding keys and a great open attractive face distinctly visible in the dim morning light.

There is a feeling of bigness and strength about him that you find in no other alarm. If he is oiled every other year there is no telling how long he will last.

\$2.50

Sold by Jewelers only. Three Dollars in Canada.

THE FIRST BIG BEN ADVERTISEMENT. It appeared on page 39 of the September 24, 1910 Saturday Evening Post

BIG BEN STYLE 1

1909 to 1918

Identified by three assembly screws through the front of the case

George Kern was born and raised in Germany and went to work at the Junghans clock factory. He came to the United States to avoid army conscription and found work in a New York machine shop. “Ernest Roth, general manager of the Western Clock Mfg. Company, was in a New York restaurant about 1905 when he overheard a stranger speaking in German. Able to understand, Roth began a friendly conversation with Kern that resulted in Kern being hired to head the clock works’ old experimental department, called the ‘model shop.’ His first order: Design a dependable and sturdy alarm clock.

“Kern went to work on it. Everyone agrees, including Ernest Roth, son of the senior Roth, that Kern deserves complete credit for the invention of the clock that was to make the company phenomenally successful. The new clock was named Big Ben.”²

Tooling was being made for the Big Ben alarm clock by the first quarter of 1908,³ the first Big Bens were sold in 1909, and they were first nationally advertised in the Sept. 24, 1910 *Saturday Evening Post*. U.S. Trademark #72,178 for “BIG BEN” contains the statement “The Trade-mark has been continually used in our business since Mar. 16, 1908.” That is the date of Gaston LeRoy’s advertising department report in which he proposed the name “Big Ben”, as discussed in the following section, “Big Ben Advertising and Promotion”.

On June 9, 1908, Kern was granted patent #890,066 entitled “Alarm Clock” (see upper two figures on cover). The patent’s two drawings show an ordinary Western Clock Mfg. Co. movement housed in a new style case invented by Kern. The significant feature of this case is the large bell-back which completely envelopes the inner case back and is an integral part of the case, while on other early bell-back alarm clocks the bell was placed there almost as an afterthought.

Kern designed a new alarm clock movement, and applied for a patent on July 1, 1908. This patent was granted November 7, 1908 as #904,333 (lower left figure on cover). The Big Ben movement incorporates an intermittent alarm feature that is an improved



Figure 1 Style 1 Big Ben alarm clock made in 1908. This is the earliest Big Ben yet located. The back has patent dates up to June 9, 1908.

There is no date on the movement (later examples do have movement dates). Note the early form of numerals.



Figure 2 Style 1 Big Ben made September 26, 1910. It has the familiar type of numerals. The name BIG BEN on the dial without “Westclox” was used through 1916.

version of the “repeating” alarm described in patent #855,775 issued June 4, 1907.

Kern was granted patent #958,930 on May 10, 1910 for improvements to the alarm mechanism (see lower right figure on cover). With several major and many minor changes this movement was used in the Big Ben leg model alarm clock from 1908 to 1935, and in the Big Ben Loud Alarm from 1935 to 1956. It was also revived in 1970 for the Big Ben leg model reproduction.⁴

The Big Ben case is covered by design patent Des. 41,725 issued to Kern on August 29, 1911.

Big Ben clocks made from 1908 to mid-1910 have a dial different from that usually seen (see figure 1). In mid-1910, the dial was changed to have the familiar type of numeral (see figure 2).

A significant change was made to the Big Ben movement in late 1912. To make it easier to repair the clock, the back plate was redesigned so that removable bridges held the mainsprings. The time mainspring barrel assembly was changed again in 1913 when a new ratchet and click arrangement was implemented. Kern’s patent #1,086,719 issued Feb. 10, 1914, covers the removable alarm mainspring assembly.

BIG BEN ADVERTISING AND PROMOTION

The success of the Big Ben was due not only to steadily improving construction but also to the unique advertising campaign carried out by advertising manager Gaston LeRoy.⁵ LeRoy’s advertising report dated Mar. 16, 1908⁶ proposed the name “Big Ben” for the new clock and outlined possible advertising strategies. LeRoy recognized that The Western Clock Manufacturing Co. was associated with cheap alarm clocks and recommended that the new clock carry the trademark “Big Ben” and not the company name.

LeRoy’s advertising referred to Big Ben as “he” and made the clock appear as a friend or a part of the family. A Western Clock Co. advertising booklet from 1912 states the following: “Big Ben was on the market a year before he was advertised and dealers then said he could not succeed. After less than a year of advertising he was pronounced the biggest clock success of years. He is known wherever people live.”⁷

It was during this period that the trademark “Westclox” first appeared. It was used on the backs of Big Bens from 1910 through 1917, and at the bottoms of a few dials as early as 1911. From 1917 on the dials were consistently marked “Westclox Big Ben.” “Westclox” was registered as a trademark on January 18, 1916. The registration contains the statement “The trademark has been continuously used in the business of said corporation since the Month of November, 1909.”

In 1917, the name “Westclox” started appearing on the dial above the words “Big Ben”. From 1917 to ca. 1922, “Westclox” was in italics (see figure 3); from ca. 1923 – ca. 1927, “Westclox” appeared in Roman font with a flat-top “X” (figures 4 and 5), and starting ca. 1928 the “Westclox” had a loop-top “X” (figure 6).

The first of many nationwide Big Ben advertisements was carried on page 39 of the Sept. 24, 1910 *Saturday Evening Post*. From that time on, Westclox regularly advertised in the *Post*, many times with a full-page ad on page one. Westclox advertisements also appeared in *Good Housekeeping*, *McCall’s*, *Delineator*, *Pictorial Review*, *Collier’s*, *The American Magazine*, *The Farm Journal*, *The Literary Digest*, and other publications. The advertising campaign certainly proved successful. In January of 1911 only 7,000 jewelers were selling Big Ben, but by March of 1914, 20,000 jewelers were selling Big Ben with 3.5 million sold.⁸ Big Ben continued to sell very well and 40 million had been made by 1956.

The first Big Bens had “MADE IN U.S.A.” stamped on the lower left of the back. In 1910 a circular logo with “MADE BY WESTCLOX, LA SALLE, ILL, U.S.A.” was used. From 1911 to 1914 the same words (without the circle) were placed at the bottom of the back, partially obscured by the rear leg. In addition, clocks made for the U.S. market from 1911 to 1913 have a circular logo stating “PAT’S INFRINGED IF RESOLD UNDER \$2.50”, “REG U.S. PAT. OFF”, “BIG BEN”. Westclox was enforcing a retail price of \$2.50 for BIG BEN at this time. A sales pamphlet states:

“BIG BEN is a handsome, well built, refined and bright looking fellow with a clean-cut open face and a deep cheerful voice—a well-dressed, steady and punctual chap, up to the minute and always on the job.

“Works 36 hours at a stretch, runs overtime when needed—guarantees to wish you a good morning when you want and either way you want—continuously for eight minutes, intermittently for fifteen.

“Kind of p’ticular and very exclusive. Works only for *jewelers* and then *only* for *certain jewelers*—those that agree to sell him for at least \$2.50. Will never work again for those that break their pledge.

“Big Ben is without exception the finest sleepmeter made—the best looking, the best built, the best running—he is handled by the best dealers, under the best policy, at the best profit.

“Big Ben always comes to you straight from home, LaSalle, Illinois—but he only comes upon receipt of signed price agreement. We pay his railroad fare on all orders for a dozen or more, we brand him with your name in lots of 24.”⁹

The wholesale price of BIG BEN in 1911 – 1912 was \$1.50 each. In case lots of 24, BIG BEN was \$1.45 including freight and dealer name imprinting on the dial.¹⁰

In 1914 a new logo stating “Made in LaSalle, Ill., U.S.A.” at the lower left of the back was introduced, first without a circle and then with a circle. In 1915 it was changed to “Made by Westclox, LaSalle, Ill., U.S.A.” in a circle. Finally in 1916 and 1917 the logo “MADE BY WESTCLOX, LA SALLE, ILL, U.S.A.” without a circle was placed on the lower left of the back.

BIG BEN STYLE 1 WITH BRASS BEZEL AND CELLULOID COVERED DIAL

Examples of a Big Ben style 1 with celluloid covered dial and brass bezel and back have been reported. They have movement dates from 1912 to 1915. These clocks have the following features:

- Celluloid covered dial.
- Bezel, legs, pendant and alarm sliders are brass that is not nickel plated.
- Back bell is brass plated steel.
- The back bells appear to be leftovers from older production, and have a last patent date of 1908, 1910 or 1911.

Some people have taken a regular Big Ben style 1 clock and removed the nickel plating to make it into a brass Big Ben. If you examine the riveting of the legs and pendant, you may see evidence that they have been removed and reattached. Also, there may be remains of nickel plating on the alarm sliders where they attach to the inner back. Also, if it has a regular paper dial (not celluloid covered), it is not an authentic brass Big Ben.

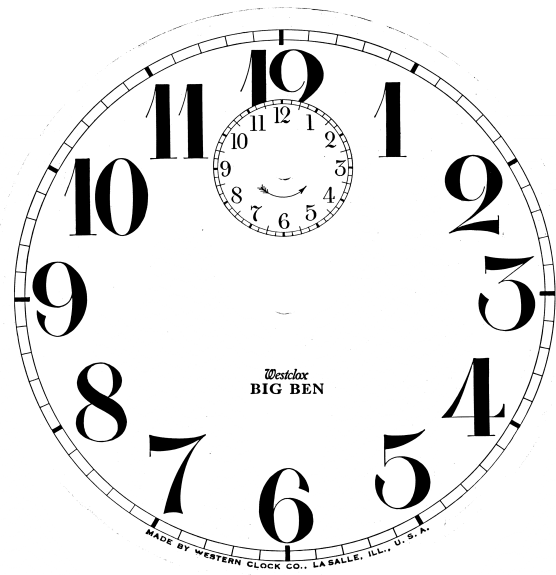

Figure 3 “Westclox” in Italics was used on the Big Ben and other Westclox clocks and watches from 1917 to 1922.

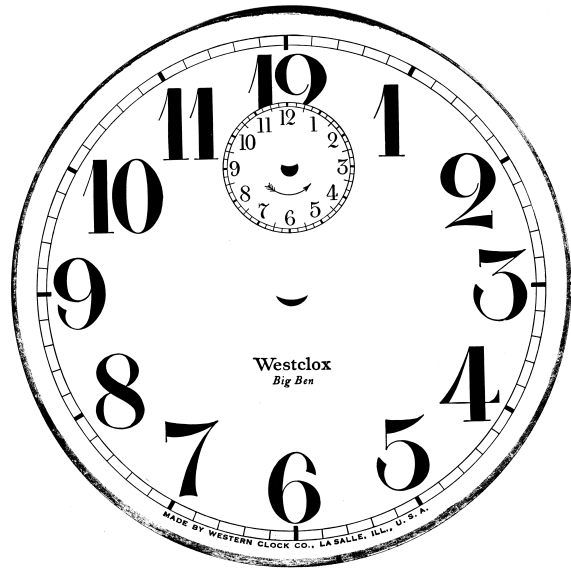

Figure 4 Starting in 1923, “Westclox” was put in Roman type face.

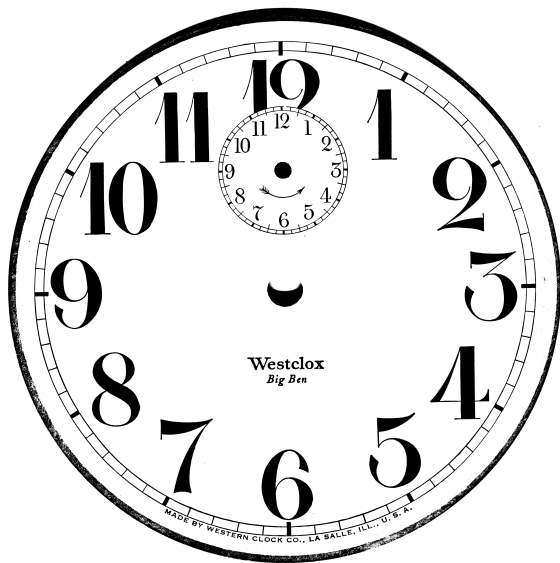

Figure 5 Starting in 1924, on Big Ben style 1a, the lettering at the bottom of the dial was made narrower.

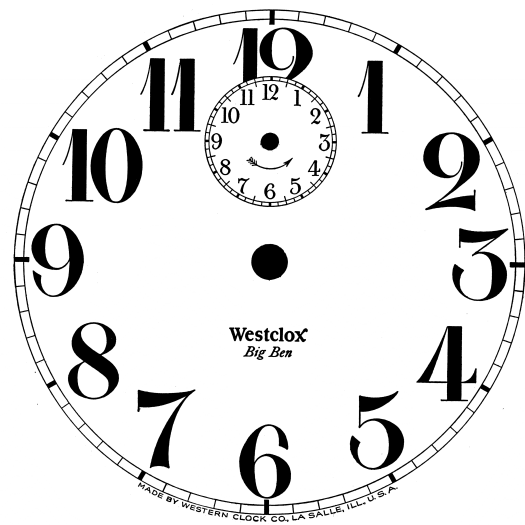

Figure 6 In 1928, the lettering of “Westclox” was changed to have the projection from the letter “x”.

BIG BEN STYLE 1a

1918 to 1935

Identified by having no screws through the front of the case

In 1918¹¹ the Big Ben case was improved to make it dustproof, as described in patent #1,300,278 issued to Kern on April 15, 1919. This dustproofing is accomplished by fittings around the set knobs and winding keys and on the regulator. The style 1a can be distinguished from style 1 in several ways:

- Style 1 has three screws through the bezel visible from the front, style 1a doesn't (compare figures 3 and 7);
- Style 1 has two screws holding the bell back, style 1a has three. Style 1a has four holes in the back to access the movement cap screws;
- Style 1 has the legs and pendant riveted to the case, on style 1a they screw on. The first style 1a cases had double-hexagon legs, but after about a year they were changed to standard single hex form.

The movement was changed for style 1a so that the mounting nuts were on the back. The movement was mounted to the inner case back.

George Kern died on July 27, 1918 from a ruptured appendix, but his basic clock design lived on for years.

About 1920 the luminous dial using radium paint was introduced. From that time on, Baby Bens first and then Big Bens were available with either the plain or luminous dial. Big Ben style 1a continued in production until its discontinuation in 1935. The movement was then used with minor changes in Loud Alarm models until 1956.



Fig. 7 Style 1a Big Ben dated January 9, 1922.

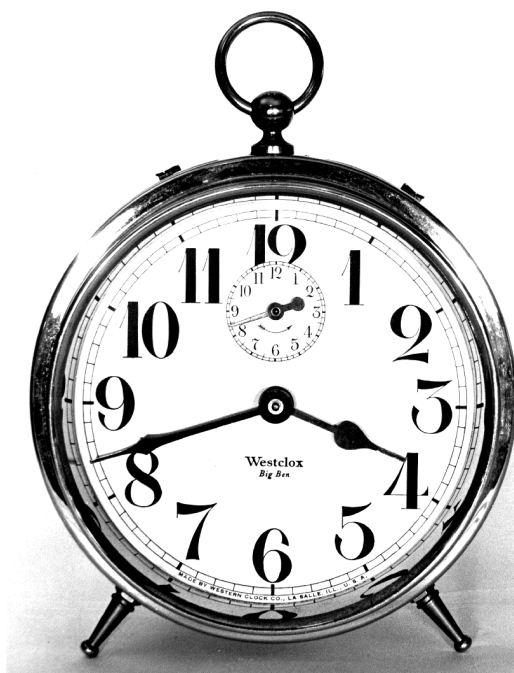

Fig. 8 Style 1a Big Ben dated August 2, 1922.

BABY BEN TWO INCH

1910 to 1912

No name on dial

Alarm dial is at the 6:00 position

Gaston LeRoy mentioned the possibility of a smaller version of the Big Ben in his March 1908 advertising report.¹² The first, early version of the Baby Ben was made with a variation of the “2 Inch” movement that has an alarm mechanism added on to the rear, forming a “two layer movement.” We thus refer to this clock as the “Baby Ben Two Inch”, and examples dating from 10-18-10 to 5-15-12¹³ are known to exist (see figure 9). This clock has no name on it, just the patent dates Oct. 28, 1902; June 9, 1908; and Dec. 15, 1908 on the back.

The following brief history is summarized from Westclox department reports of 1908 to 1912.¹⁴

Starting in the second quarter of 1909, case body drawing tools and some movement tooling was made for a clock referred to as the “Little B. B.” In the second quarter of 1910, tooling was being made for a clock referred to as “Little Ben” and Little B.B.” (in a few places it appears that the name Little Ben had been changed to Little B. B.) The second quarter 1910 (Mar. 28 – June 18) manufacturing report states “We have made about 200 Baby Ben movements so far and after vacation we intend to start assembling them regularly and slowly increase the quantity as we get the help broken in to work on them.” The 3Q 1910 Engineering Department report states “Work on the “Little Ben” drawings is going forward.”

The 4Q 1911 Manufacturing report (dated Jan. 12, 1912) states “The baby Ben clock at present is gotten out in connection with the two inch movement. The production of two inch is 300 [units per day] and the baby Ben 60. This occupies a floor space of 2048 square feet. To produce 1000 baby Ben will take a floor space of nearly 3000 square feet, which room will have to be provided.”

The baby Ben Two Inch is so much different from the main line of Baby Bens, that it is considered by many collectors to not be a “real” baby Ben at all. It certainly does not have a good movement design, and in fact a good movement for the Baby Ben was not produced until late 1914 or early 1915 (the “Type 2 movement discussed in the next section).



Fig. 9 The “Baby Ben Two Inch” 1910 to 1912.

Big Ben

baby Ben

Made in LaSalle and
Paris Ill. by Westclox



—see who's here!

MEET little brother—baby Ben—the only alarm clock rated high enough to keep National company with Big Ben.

baby Ben *is* Big Ben in miniature—a well trained little time-piece with more good-natured *get-ups* in that silvery-toned call than most alarms twice his size.

He snugs cozily but business-like into any little spot or corner—fits the scheme of a dainty boudoir—makes himself *useful* on milady's dressing table, or right *at home* in her traveling bag.

baby Ben is just half the size of Big Ben; exactly $3\frac{1}{4}$ inches from *foot* to *ring*. His face is clear and bold; his ring is silvery and cheerful—a wee bit sharper and softer than Big Ben's, but just as insistent.

Most jewelers have adopted baby Ben, and will gladly show him off. If not in stock, a money order addressed to *Westclox, La Salle, Illinois*, will bring him prepaid. baby Ben and Big Ben are priced the same—\$2.50 in the States; in Canada \$3.00.

THE FIRST BABY BEN ADVERTISEMENT It appeared on page 1 of the September 25, 1915 Saturday Evening Post.

BABY BEN STYLE 1

1912 to 1930

The “baby Ben Two Inch” proved to be unsatisfactory, and was replaced with the Baby Ben Style 1 in 1912 (figures 10 - 16). The following information was summarized from Westclox department reports.¹⁵

The engineering report from first quarter 1911 states “NEW CLOCK DRAWINGS – LITTLE BEN REPEATER. Drawings have been started on this new clock and some have been delivered to the tool room.” The 2Q1911 report states “The Little Ben Repeater drawings are completed.”

The 2Q1911 and 3Q1911 reports list many tools made for “Little Ben Repeater.” The 4Q1911 report again lists many tools for this clock and then states “We have about completed the Tools for Little Ben Repeater.” At this point the name “baby Ben” must have been applied to the “Little Ben Repeater”, as the advertising department states in their Jan. 13, 1912 report: “The manufacturing department is working on a new baby Ben which will be brought out in the future and a campaign of advertising and sales will be inaugurated as soon as a sufficient stock can be accumulated to provide for the demand created by such a campaign. It will certainly be necessary to have sufficient room to take care of these in the same manner as Big Ben (packing, labeling and boxing.)” Also, the 1Q1912 tooling department report lists more tools for “baby Ben” and states that “The baby Ben tools are completed.” However, tool reports for the next three quarters list more tools made for baby Ben, but these may have been improved versions of existing tools, or duplicate tools for increased production.

The Jan. 27, 1913 sales report states “baby Ben shows the greatest increase, running over 100%. The new model of this clock was available in limited quantities about Sept. 1 [1912], but as a sufficient stock could not be made up it was decided to wait until this year to push it strongly.” Evidently, the clock was not as reliable as desired, so more improvements were made, and baby Ben was not officially introduced to the public until advertised on page one of the September 25, 1915 *Saturday Evening Post*.

Jeffrey Wood¹⁶ has documented 3 major types of early baby Ben Style 1 movements:

Type 1) Going barrel for both time and alarm mainsprings, time mainspring is 1/4” wide. Time key has female thread.

Type 1a) Time barrel changed to winding (or safety) barrel to avoid center pinion damage when the mainspring breaks. Time mainspring width 7/32”. Time key has male thread. This movement was made for a very short time in the fourth quarter of 1914.

Type 2) Time mainspring width increased to 5/16” by using a “domed” time barrel bridge to gain height and making the clock 1/8” thicker. The wider mainspring was made thinner and the length was increased, thus providing adequate power for well over a day.

Movement types 1 and 1a were not much more satisfactory than the Two Inch baby Ben movement. The type 2 movement was more satisfactory and was used until being replaced with a new design in late 1926.

In late 1926 the case pendant was changed from oval to round (compare figures 15 and 16), and the rear leg was changed from a flat to a rounded end. A new movement was phased into production during late 1926 and early 1927. The alarm barrel was changed from a going barrel to a winding barrel, and the alarm winding direction was changed to clockwise. The gearing was modified to change the beat rate from 15,000 beats per hour to 14,400 beats per hour. This movement, with and minor changes, remained in production through 1960, when it was replaced by the single key wind Baby Ben movement.

The dials on the first baby Bens are made of celluloid over paper (see figure 10), and the regular paper dial was used starting in the first quarter of 1914 (see figure 11). The name on the

clock was “baby Ben” until 1916 when it was changed to “Baby Ben” (see figure 13). In 1917 the trademark “Westclox” was added above the words “Baby Ben.” From 1917 to ca. 1922, “Westclox” was in italics (see figure 14); from ca. 1923 – ca. 1927, “Westclox” appeared in Roman font with a flat-top “X” (see figure 15), and starting ca. 1928 the “Westclox” had a loop-top “X” (see figure 16). The company name was put at the bottom of the dial starting in late 1915 (see figure 12).

About 1920 the luminous dial using radium paint was introduced. From that time on, Baby Bens first and then Big Bens were available with either the plain or luminous dial. A few Baby Ben style 1 clocks ca. 1927 have white painted metal dials. The style 1 Baby Ben was made until 1930.



Fig. 10 Style 1 baby Ben dated May 21, 1913. Celluloid covered paper dial with early style numerals. These numerals are like those on Big Ben style 1, 1a and 2.

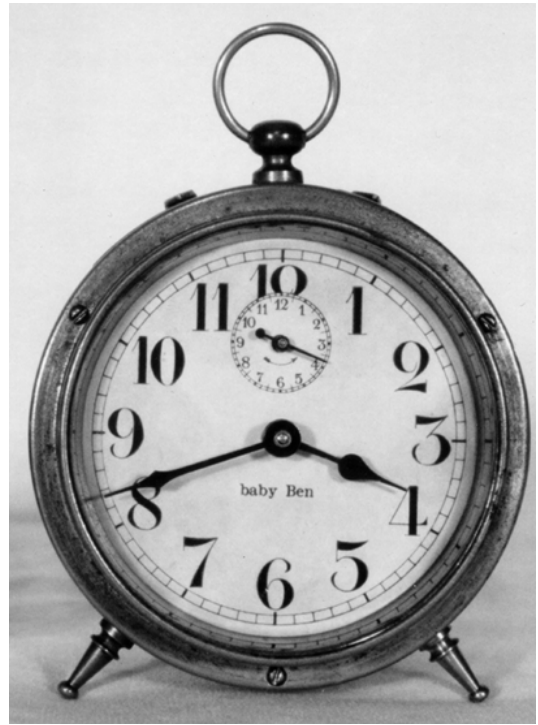

Fig. 11 Style 1 baby Ben dated May 17, 1915. Paper dial with the familiar type of numerals.

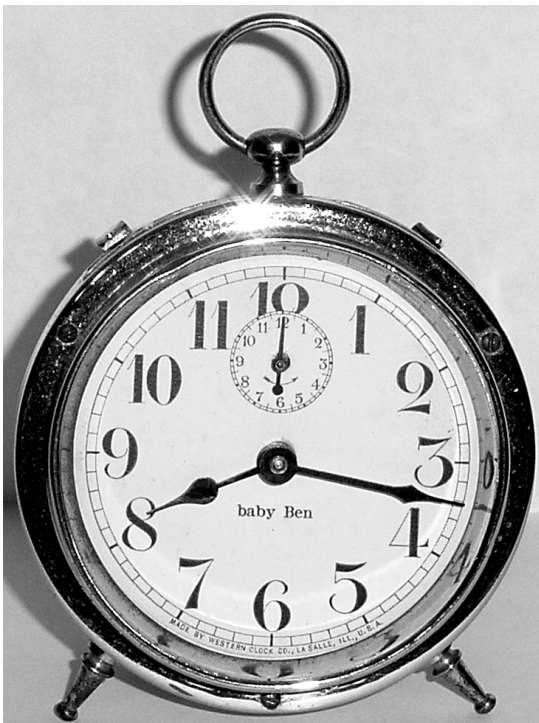

Fig. 12 Style 1 baby Ben dated January 23, 1916. The company name is now shown at the bottom of the dial.

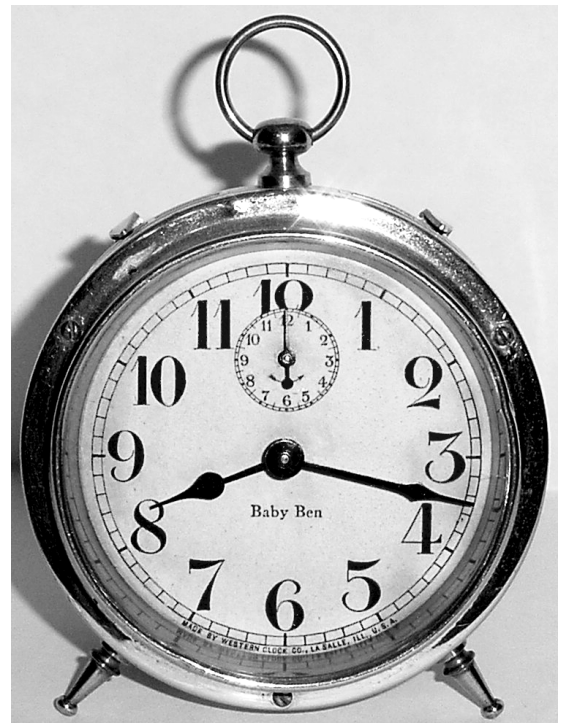

Fig. 13 Style 1 Baby Ben dated March 30, 1917. Notice that the first "B" in "Baby" is now upper case.



Fig. 14 Style 1 Baby Ben dated March 1, 1920. Notice that “Westclox” is in italics.



Fig. 15 Style 1 Baby Ben ca. 1925 - 1926 showing “Westclox” in Roman font with flat top “X”. This dial came in two variations: Narrow lettering at the bottom of the dial (as in the previous dial) from 1923 – 1925, and wide lettering (as shown here) from 1925 – 1927.



Fig. 16 Style 1 Baby Ben dated January 1929. Note the loop top “X” and ball shaped pendant. (Alarm hand is from a later style clock).

STYLE 2 BIG BEN AND BABY BEN

Polished nickel finish: 1927 - 1932

Crackle painted finish: 1928 - 1930

Solid painted finish: 1930 - 1932

Butler nickel finish 1930 - 1932

The style 2 Bens were put into production around mid-1927, and were first advertised that fall. The movements in the style 2 Bens are identical to those in the style 1 Bens of the same time period. The difference is in the case—a die-cast base replaced the legs, and the ring on top was omitted. (Note that the front of the base is longer than the back – we have often seen clocks with the base installed backward!)

Design patent Des. 72,332 issued to H. A. Schierholtz on March 29, 1927 covers the style 2 case design. Max Schlenker was responsible for the design of the base.¹⁷

The first style 2 Bens have a polished nickel finish just like the style 1 Bens. White non-luminous dials or black luminous dials were made, which had the lettering “Big Ben DeLuxe” or “Baby Ben DeLuxe.” (A few white painted metal dials have been seen on Baby Bens.)

Crackle painted finishes in green, blue, and pink (“old rose” in Westclox literature) were introduced in 1928. The very first of these crackle finish clocks have white paper dials, but by summer of 1928 gold colored paper non-luminous dials were being used. In fall of 1929 crackle finish Bens with gold color luminous dials were added to the line. The Big Ben luminous dials were gold colored paper while the Baby Ben luminous dials were gold painted metal.

Starting in 1930 the dials no longer said “DeLuxe” on them, just “Big Ben” or “Baby Ben” as on the style 1 clocks.

Solid color painted finishes were introduced in 1930 and the crackle finish was discontinued. The solid colors were light green, light blue and pink.

A fancy dial with raised gold leaf numerals was introduced in 1930, about the same time as the solid case finish. These dials have slight off-white or beige backgrounds (the background colors vary due to differences in how they have aged) with fancy skeleton hands. This dial was used in the solid color painted cases, and in “butler” (brushed) finish nickel cases.

At this time, solid color clocks were available with either the standard gold luminous dial or the fancy raised gold numeral non-luminous dial; polished nickel finish clocks were available with the white non-luminous dial or black luminous dial; and butler nickel clocks had the raised gold numeral dial. (More research needs to be done by studying ads and catalogs to determine if the above list is accurate. For example, was there a butler finish clock with luminous dial?)

The nickel finish clock was in production through the period in which the painted clocks were produced, but judging by the relative numbers of them we have seen, the painted clocks were far more popular.

The style 2 Bens were discontinued in 1932.

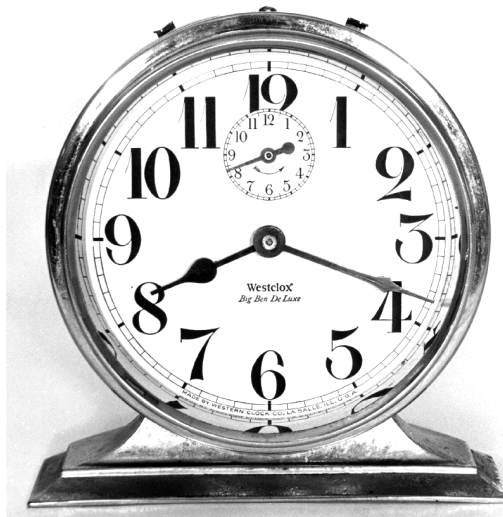

Fig. 17 Style 2 Big Ben in polished nickel case with white dial, ca. 1927

STYLE 3 BIG BEN AND BABY BEN

Identified by concave curves on base

Big Ben style 3: 1931 to 1934

Baby Ben style 3: 1932 to 1934

“A New Big Ben Chime Alarm, which has been termed ‘The First Polite Alarm Clock In History’ because of the pleasant manner in which it awakens people from their slumber” was introduced in mid-1931. “This Big Ben Chime alarm has a two voiced alarm. First, there’s a series of gentle chime calls designed to awaken the light sleeper without disturbing the sleep of the entire household. If this gentle alarm does not awaken the sleeper there is a loud, steady call in reserve that will awaken the most sound slumberer.”¹⁸

Design patent 85,916 was issued to Henry Dreyfuss on January 5, 1932. This style 3 case was first used to house the new Big Ben Chime Alarm (see figure 18).

The first style 3 Chime Alarms had the alarm shutoff lever in a curved slot, later the standard type of pull on-off switch was used.

In 1932 the Baby Ben style 3 was introduced. At first, Big Ben and Baby Ben style 3 clocks came only in black finish with nickel trim. In December 1932, a special Christmas model Baby Ben was made.¹⁹ It had a dark red (sometimes called brown) finish with copper trim, and was the first Baby Ben with the loud-soft switch to control the alarm volume. This clock was so popular that it became a regular model.²⁰ The “butler finish” Big Ben Chime alarm was also introduced about this time. “Butler finish is a special treatment applied to nickel plating which gives it a soft, satin-like appearance. This finish is produced in our buffing department.”²¹

Baby Ben style 3 was also made in gray finish with brass trim, and a few were made in ivory finish with brass trim.

Big Ben style 3 has a flat glass, and Baby Ben style 3 was the first Ben to have a convex glass. The style 3 Bens were discontinued in 1934. They were made for a shorter time than any other style of Ben (except for the baby Ben 2 inch, which is not considered a “real” Baby Ben).

Plain or luminous dials were available, see figure 19 for the style of luminous hands and numerals.



Fig. 18 Style 3 Big Ben Chime Alarm in black case with non-luminous dial.



Fig. 19 Style 3 Baby Ben with luminous dial

STYLE 4 BIG BEN AND BABY BEN

Identified by Convex curves on base

Big Ben Style 4 Chime alarm: 1934 - 1939

Big Ben Style 4a Loud Alarm: 1935 - 1939

Baby Ben Style 4: 1934 – 1939

(Style 4a is thicker than style 4)

The style 4 Ben case is a modification of the style 3. There is no matting ring between the dial and the glass, and the base has two convex curves (one on each side) instead of four concave curves. Both Big Ben and Baby Ben style 4 have a convex glass.

Baby Ben style 4 was introduced in 1934 and came in two case colors. The ivory case with brass trim has a white non-luminous dial with black figures, or a brown-banded luminous dial. The black (actually called gunmetal, a grayish metallic paint) case with nickel trim has a white non-luminous dial with black figures, or a solid black luminous dial. The alarm winding key is lower on the back than on style 3, and there is a sliding cover on the regulator slot (also used on styles 5 – 8).

Big Ben style 4 has more variations than Baby Ben style 4. In 1934 the style 4 Big Ben Chime Alarm was introduced. At first it was made in a black finish with nickel trim, and a green metallic finish with nickel trim. About April 1936 the ivory finish with brass trim replaced the green finish clock, and gunmetal finish replaced the black finish.²² Black, gunmetal and green clocks have a white dial with black numerals or a black dial with luminous numerals. Ivory clocks have a white dial with black numerals or a brown-banded dial with luminous numerals.

The Chime Alarms produced through early 1935 differ from the later, standard ones in several respects. They don't have the name "Chime Alarm" on the dial, and they have the words "Westclox" and "Big Ben" printed with the same style of lettering as style 3 Chime Alarms. The hands on luminous dial clocks are made from the same blanks as non-luminous hands ("simplified skeleton style") but are nickered, with the luminous paint applied from behind. There is close spacing between the time winding key and time set knob, just like the style 3 Chime Alarm.

Starting in early 1935, the Chime Alarm was produced with "standard" features. There is wide spacing between the time winding key and time set knob, achieved with intermediate gearing on the time main wheel bridge. The dials have the label "Chime Alarm." Luminous hands on both gunmetal and ivory clocks are solid (not skeleton) nickered blanks with luminous paint applied to the front (did some ivory clocks use unplated brass hand blanks?).

In March 1935, the Big Ben Style 1a was discontinued,²³ and Big Ben Style 4a Loud Alarm was introduced. Big Ben style 4a appears similar to style 4 but the case is approximately 1/4" thicker to accommodate the Loud Alarm movement, which is thicker than the Chime Alarm movement. The "Loud Alarm" movement is basically the same as the movement used in Big Ben style 1a. The style 4a Big Ben Loud Alarm was made in a gunmetal case with nickel trim and

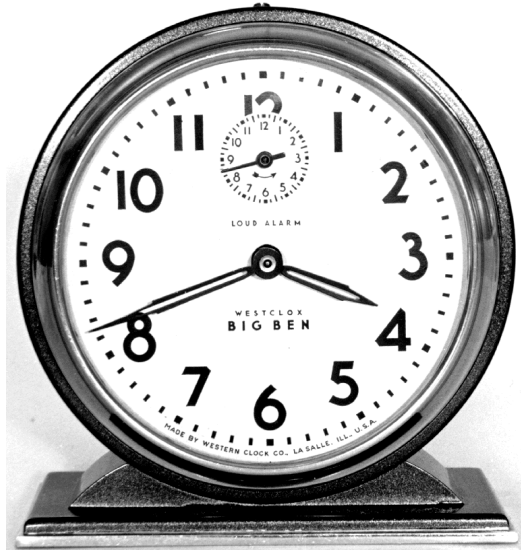

Fig. 20 Style 4a Big Ben Loud Alarm in gunmetal case with white non-luminous dial.

had a white dial with black numerals or a black dial with luminous figures. The cases have a hanger on the back.

In late 1936, the company name was changed from “Western Clock Company” to “Westclox Division of General Time Instruments Corporation.” This change appeared on dials ca. late 1936 to early 1937. Style 4 and 4a were discontinued in 1939.

DIFFERENTIATING STYLE 4 FROM STYLE 5 DIALS

The style 4 dial has curved tails on the numerals 6 and 9, the style 5 has straight tails. There are differences in the lettering too.

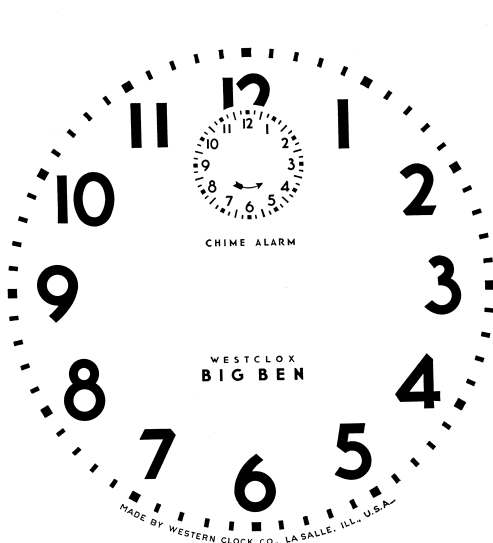

Fig. 21 Style 4 Chime Alarm dial. Note the curved tail on the 6 and 9.

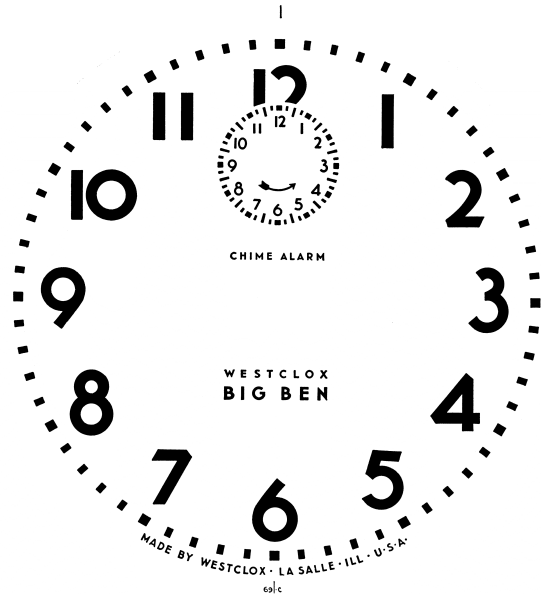

Fig. 22 Style 5 Chime Alarm dial. Note the straight tail on the 6 and 9.

STYLE 5 BIG BEN AND BABY BEN

Big Ben Style 5 Chime Alarm: 1939 - 1949

Big Ben Style 5a Loud Alarm: 1939 - 1946

Big Ben Style 5 Loud Alarm: 1946 - 1949

Baby Ben Style 5: 1939 - 1949

(Style 5a is thicker than style 5)

The style 5 case design was first used in 1938 for the electric Big Ben Chime Alarm. In 1939 the wind-up style 5 Bens were introduced. Henry Dreyfuss designed this case and General Time applied for the patent on November 19, 1938. The patent was issued on April 11, 1939. Other well known designs by Dreyfuss²⁴ are the Honeywell round thermostat, the Princess phone, and the Hudson J-3 streamlined locomotive for New York Central Railroad. Dreyfuss also designed the box for the style 5 Bens.

Baby Ben style 5 and Big Ben Style 5 Chime Alarm were made in two colors, gunmetal with nickel trim and ivory with brass trim. Gunmetal cases have a white dial with black numerals, or a black dial with luminous numerals. Ivory cases have a white dial with brown numerals, or two different types of luminous dial (brown-banded from 1939 – 1948 and solid brown in 1948 and 1949).

Hands on non-luminous gunmetal clocks are blued steel of the form shown in figure 23 (“simplified skeleton style”). Hands on non-luminous ivory clocks are brown and of the same shape. Hands on luminous gunmetal clocks are solid (not skeleton) nickered blanks with luminous paint applied to the front. Hands on ivory luminous clocks are lacquered brass blanks with luminous paint on the front.

The style 5a Big Ben Loud Alarm was made from 1939 to 1946. It came only in gunmetal with nickel trim, and either a white dial with black numerals or a black dial with luminous numerals. The style 5a appears similar to the style 5 but the case is thicker to accommodate the Loud Alarm movement, which is thicker than the Chime Alarm movement. In 1946, the Loud Alarm movement was redesigned to make it thinner, so it would fit into the thinner style 5 case. At this time, the style 5a Loud Alarm was replaced by the style 5 Loud Alarm, still only in gunmetal finish.

Most style 5a Big Ben Loud Alarms have a hanger on the back, but it was discontinued in late 1945 or early 1946.

Westclox switched over to production of war material during World War II. Consumer clock production ceased July 31, 1942 and resumed in 1945. A Baby Ben “Waralarm” was made during WWII.²⁵ Movements made during this time were not nickel plated as they usually were.

The style 5 Bens were made through 1949.

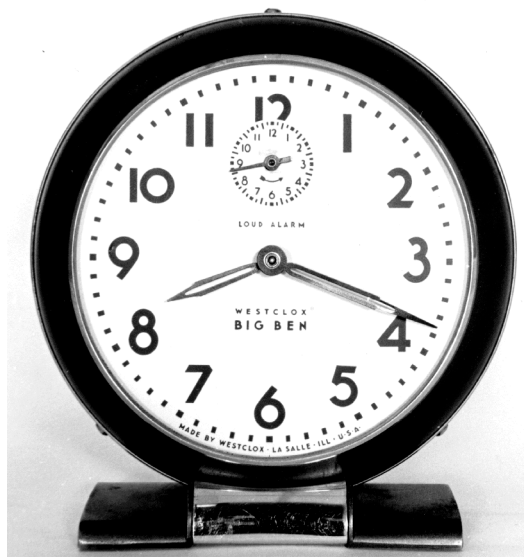
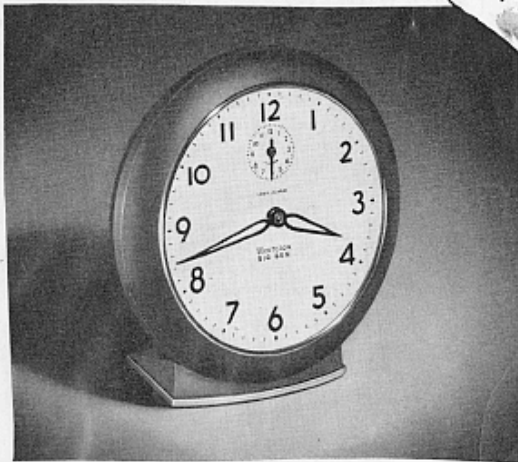
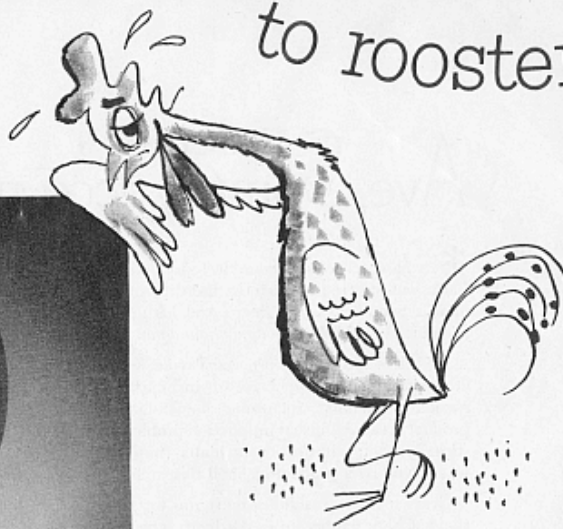

Fig. 23 Style 5 Big Ben Loud Alarm in gunmetal case with white non-luminous dial.

unfair to roosters!



BIG BEN LOUD ALARM, SPRING-DRIVEN. He's a forceful fellow. His tick that you can hear is for those who love the constant reassurance that all is well. And his deep, intermittent "fire alarm" gong wakes the most stubborn sleepyhead. Available in black or ivory finish, Big Ben Loud Alarm costs only \$5.95. With luminous dial, he's \$6.95.

60,000,000

Big Bens and Baby Bens
have been sold throughout the world!

Probably no clocks on earth have ever served so many so well. And since each of these clocks has a personality of its own, one of them is best suited to *your* needs. Learn about the pleasant choice you have.

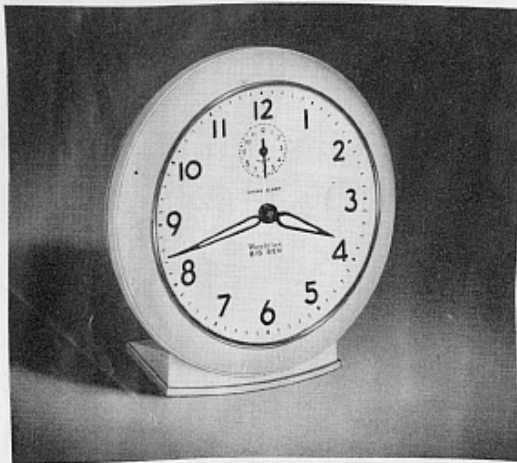

BIG BEN CHIME ALARM, SPRING-DRIVEN. This Big Ben is a gentle chap. His quiet tick is for those who do not consider the tick of a clock to be a lullaby. He has a two-voice alarm. When it's time to rouse you, "first he whispers . . . then he shouts." Available in ivory finish only, Big Ben Chime Alarm costs \$6.95. Luminous, he's \$7.95.



BABY BEN SPRING-DRIVEN ALARM. He is the popular "little brother" of Big Ben. He is so dependable, has a tick so quiet, that you can sleep like a baby. He raises his voice only to call you pleasantly in the morning. You can even adjust his steady, cheerful alarm to loud or soft, as you wish. Available in black or ivory finish, Baby Ben costs only \$5.95. With luminous dial, Baby Ben is \$6.95.

Spring driven or electric **WESTCLOX*** makes 'em as you like 'em

PRODUCTS OF **GT** CORPORATION

WESTCLOX, La Salle-Peru, Illinois • In Canada: Western Clock Company, Ltd., Peterborough, Ontario. Prices quoted for U.S.A. only, do not include tax and are subject to change. * Trade Mark Reg. U.S. Patent Office.

The rooster is crying because he has been replaced by Big Ben and Baby Ben alarm clocks! This is one of our favorite advertisements. It illustrates style 6 Big Ben and Baby Ben. From the Saturday Evening Post August 21, 1950

STYLE 6 BIG BEN AND BABY BEN

1949 to 1956

Henry Dreyfuss designed the style 6 case for the Big and Baby Bens, and they were introduced to the market in 1949. This design was not patented. Notice the new style of hands and that the entire number 12 is printed on the dial (previous styles had only a partial 12 due to the alarm dial).

Style 6 Baby Bens were made in gunmetal cases with nickel trim, and ivory cases with brass trim. Gunmetal cases have a white dial with black numerals or a black dial with luminous numerals. Ivory cases have either a white dial with brown numerals or a brown dial with luminous numerals.

The style 6 Big Ben Chime Alarm was made only in ivory cases with brass trim. These have a white dial with brown numerals or a brown dial with luminous numerals.

The style 6 Big Ben Loud Alarm was made in gunmetal cases only at first, and in 1954 the ivory case was added to the line. Gunmetal cases have a white dial with black numerals or a black dial with luminous numerals. Ivory cases have either a white dial with brown numerals or a brown dial with luminous numerals.

Almost all Baby Ben and Chime Alarm movements were nickel plated up to 1951. Style 6 was discontinued in 1956.

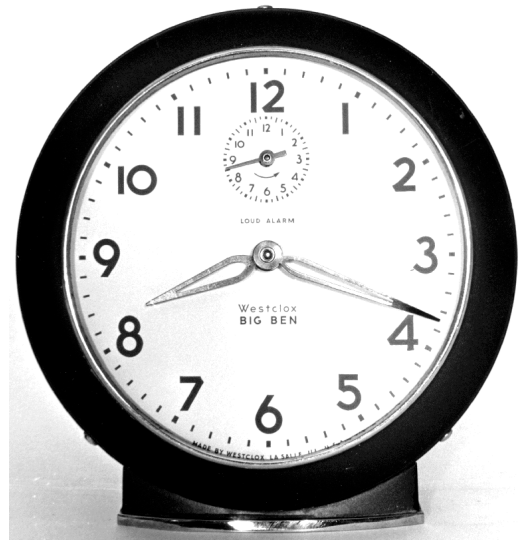

Fig. 24 Style 6 Big Ben Loud Alarm in gunmetal case with white non-luminous dial.

STYLE 7 BIG BEN AND BABY BEN

1956 to 1964 (and 1976)

Ellworth Danz designed the style 7 case. No design patent was applied for because the patent attorney said it was “just another round clock”.²⁶ This is the first Ben with concentric alarm indicator.

The standard case colors are white with brass bezel and black with brass bezel (black Big Bens up through 1958 or 1959 have nickel bezels). Black cased clocks have either a non-luminous dial that is white with black numerals and a background pattern of small light blue dots, or a luminous dial which is black with luminous figures and a background pattern of blue dots. White cased clocks have either a non-luminous dial that is white with brown numerals and a background pattern of light blue dots, or a luminous dial that is brown with luminous numerals and a background pattern of dark brown dots. The first style 7 clocks have radial numerals on the dial, and in 1958 they were changed to upright.

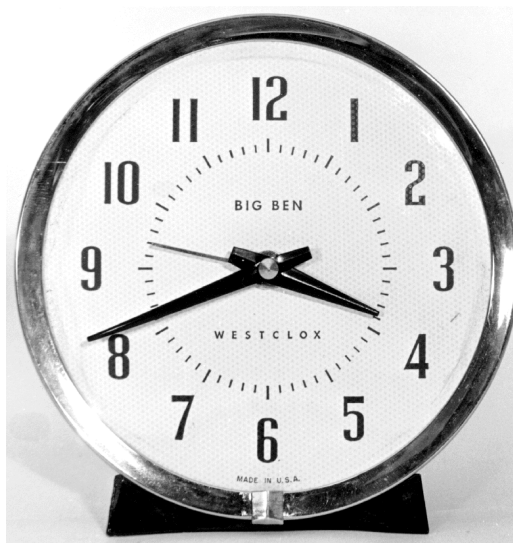

Fig. 25 Style 7 Big Ben with black case and non-luminous dial.

A new movement was designed for the Big Ben style 7. It uses a single mainspring for both time and alarm. The Baby Ben style 7 used the old two key wind movement until 1960 when a single key wind movement was introduced.

In 1958 the “Baby Ben Sequin” was introduced to honor the 69 million Big and Baby Bens of the previous 50 years. These had a pink or turquoise case with rhinestones on the front of the bezel. In 1960 a Baby Ben sequin with embossed metal numerals was introduced.

Some brass, gold and silver finished style 7 Baby Bens were made in the 1960’s. These have a silver color metal dial. A Big Ben style 7 in a gold painted case and gold color dial was also made in the early 1960’s.

Style 7 was discontinued in 1964.

The style 7 Baby Ben windup was revived around 1976. This late version can be identified as follows:

- The base is plastic, with number 58056 on the bottom. It is the same as the plastic base used on late style 8 Baby Ben clocks.
- The bezel has a matte or sandblasted finish.
- The key and knobs are plastic.
- The minute hand does not have a metal cap in the center.

This clock has been seen in boxes labeled “Special Baby Ben Buy!” It uses the aluminum movement that late style 8 clocks use.

CLOCK OF TOMORROW

1955 to 1959

Clock of Tomorrow was an elegant and expensive clock, retailing for \$12.50 at its introduction in mid-1955. In comparison, Big Ben Loud Alarm Luminous retailed for \$7.95 at the time. Clock of tomorrow was made through 1959. It was made in a white case with white dial, and black case with black dial. Both case colors have gold colored trim. The Clock of Tomorrow has a chime alarm sound.

In the early 1940's, Ralph Matthiessen, Chairman and major stockholder of General Time, suggested to Max Schlenker (chief engineer) that a key wound clock should be designed which would have all the advanced features in one clock and would be a "clock of tomorrow". The name was picked up from his request. A clock model with illuminated push-push switch, single key silent wind, quiet movement was made by engineering.²⁷

The styling of the model was not impressive, and so Ellworth Danz was given the task to come up with an appropriate style for this clock. This was one of the first projects Mr. Danz worked on,²⁸ resulting in design patent Des. 162,523 issued March 20, 1951. The clock's movement is covered by patent #2,361,128 issued to Max Schlenker on October 24, 1944.

Concerning the introduction of the Clock of Tomorrow, Mr. Danz told me the following:

"The Clock of Tomorrow was delayed by two things; production of the Bens and other key wounds was the main priority in order to fill the demand after production had ceased during world War II. Tooling for this clock was not a priority. A new marketing Manager, Joe Donahue, had come from the Shaeffer Pen Company, and he said their \$12.50 pens outsold their \$5.00 models. That was a concept new to key wound clocks – and perhaps not applicable.

"You will notice the dial on the production models differ from the one on the patent drawing. I have one of few samples made with the original dial (non luminous). I designed the style 7 Big Ben case although no patent was applied for (our patent attorney said it was just another round clock). Of course this design and construction with the first plastic lens for a Ben was based on the same concept as the Clock of Tomorrow."²⁹

I consider the Clock of Tomorrow to be part of the Big Ben family, as it has many of the same characteristics including the bell-back and removable mainspring barrel.



Fig. 26 Clock of Tomorrow in white case.

STYLE 8 BIG BEN AND BABY BEN

1964 to 1981

The style 8 Bens were made from 1964 to 1981. Design patent Des. 201,892 issued to Ellworth Danz on Aug. 10, 1965 covers the style 8 case design. Standard case colors were white with brass trim, and black with nickel trim. White clocks have a white dial with brown numerals or a brown dial with luminous numerals. Black clocks have a white dial with black numerals or a black dial with luminous numerals.

The “Fashion Brite” series of Bens in Blue, Flame, Avocado and Woodtone were made from 1970 – 1975. They used the same movement as the standard Big and Baby Bens.

In 1971 the “Big Ben Sweep” and “Baby Ben Sweep” were introduced. They have sweep second hands, and the case and dial colors were blue, green and brown. Also introduced in 1971 were “Big Ben Repeater” in avocado and bronze; and “Baby Ben Repeater” in avocado, bronze and blue.

“Big Ben Sculptura” on a tall pedestal base was first made in England,³⁰ then the LaSalle factory began to make it too. It is shown in US catalogs starting with the 1975 – 76 issue and was made in “stardust blue”, “field green” and “radiant red”.

A Big Ben Chime Alarm in white or gold mist case was made from 1967 – 1971. “Baby Ben DeLuxe” in gold or silver case and metal dial was made from 1964 – 1971.

From 1967 – 1970 the “Baby Ben Magic Touch” style 8 was made. It has a night light that is activated by pushing down on the top of the clock.

A folding travel clock shaped like a Style 8 was also made. Models with a seven-jewel movement are shown in the 1969-70 catalog, and a no jewel model made in USA dated 11-75 has been observed.

The style 8 design continued through 1980 selling along with the style 9. In 1981, its last year, it was made only as a sweep seconds hand model.³¹



Fig. 27 Style 8 Big Ben in black case with non-luminous dial.

STYLE 9 BIG BEN AND BABY BEN

Big Ben: 1979 to 2000

Baby Ben: 1980 - 2000

The style 9 Big Ben and Baby Ben case was designed by Ellworth Danz and is covered by design patent Des. 257,129 issued September 30, 1980. The style 9 was in preliminary production in LaSalle in the last month or two in 1979, and in full production in Athens, Georgia in 1980.³²

The standard case colors were black with silver bezel, almond with goldtone bezel, and white with silver bezel. Some non-luminous clocks were made at first (I don't know for how long), but later just luminous models were made. In the 1990 catalog the only non-luminous models were Big Ben and Baby Ben in white case with goldtone bezel having white dial with brown numerals.

Some decorator models of Big Ben and Baby Ben were listed in the 1990 Westclox catalog:

“Lady Ben” in both Big Ben and Baby Ben, with flower or shell patterned dials and bezels in white, slate blue and pale pink.

“Victorian Big Ben”, “Big Ben Contemporary” and “Baby Ben Contemporary” with patterned dials.

“Baby Ben Designer”, having slate blue, dusty rose or seafoam green color bezels.³³

“Big Ben DeLuxe” in Burgundy with red dial, and hunter green are shown in the 1996 catalog.

Production of the style 9 ended in October 2000 when clock manufacture at the Athens, Georgia plant was terminated (this was the last remaining Westclox plant in the United States).

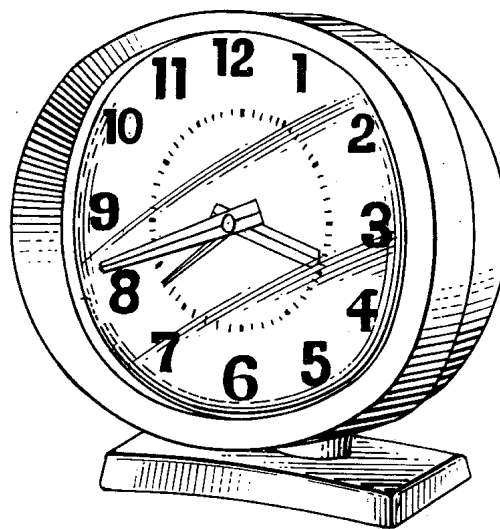

Fig. 28 Style 9 Ben as shown in the design patent Des. 257, 129

STYLE 10 BIG BEN AND BABY BEN

Starting in 2001

The style 10 was introduced in 2001. Several case and dial color combinations are available. Most dials have radial numerals, but some white clocks with white dial have upright numerals. Style 10 clocks utilize a two key wind movement, and are manufactured in China.

In 2001, General Time Corporation closed its entire operation and sold the Westclox business to Salton, Inc. From late fall 2001, until mid to late 2002, new Westclox products were difficult to find. Now, Westclox clocks are widely sold online and in stores.



Fig. 29 Style 10 big Ben in charcoal

Case with silver luminous dial.
Copyright © 2012 by William S. Stoddard (<http://ClockHistory.com>)

ELECTRIC BIG BENS AND BABY BENS

The first electric Big Ben alarm clocks were introduced ca. August 1931.³⁴ The three models introduced at this time were models 820, 830 and 840. Models 820 and 830 have a black composition (Bakelite) case, and model 840 is a mahogany case. They use the Sangamo self-starting synchronous motor. The motor runs the clock as well as winds the alarm mainspring. There is a key on the back for manually winding the alarm mainspring.

Model 820 Big Ben Electric

1931 – 1934. Black Bakelite case, non-luminous dial. Says “Model 820” and “Motor F-S1A” on nameplate. Some say “S1A” on bottom. Height 5 1/4”

Model 830 Big Ben Electric

Same as model 820 but has luminous dial and says “Model 830” on nameplate.

Model 840 Big Ben Electric

1931 – 1935. Mahogany case, non-luminous metal dial. Says “Model 840” and “Motor F-S1” on nameplate. Height 5 11/16”

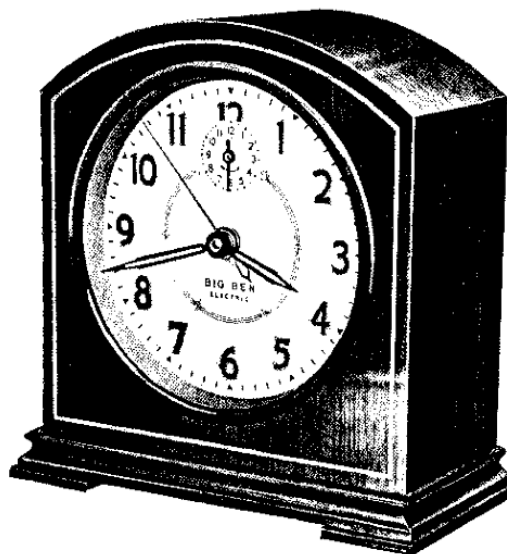
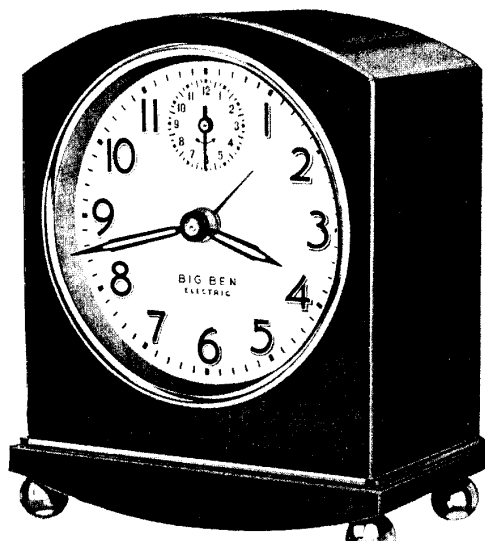

Big Ben Style 5 Electric Clocks

The electric Chime Alarm was introduced to the Westclox salesmen on January 3, 1939. The retail price was \$4.95 with plain dial and \$5.95 with luminous dial. This clock used a synchronous motor designed and made by Westclox. In 1941, the electric chime alarm was replaced by a style 5 without chime alarm. A Baby Ben style 5 electric was also made. It is quite uncommon.

Style 5 Big Ben Electric Chime Alarm

First made in 1938, market introduction Jan. 1939, discontinued 7/41. First made in gunmetal/nickel, later ivory/brass added. Base labeled "S4-D". Gunmetal back labeled "S4-D". Ivory back labeled "S4-D" with the "D" crossed out and "E" stamped above it. Second hand in front of minute hand. Height 5 3/4"

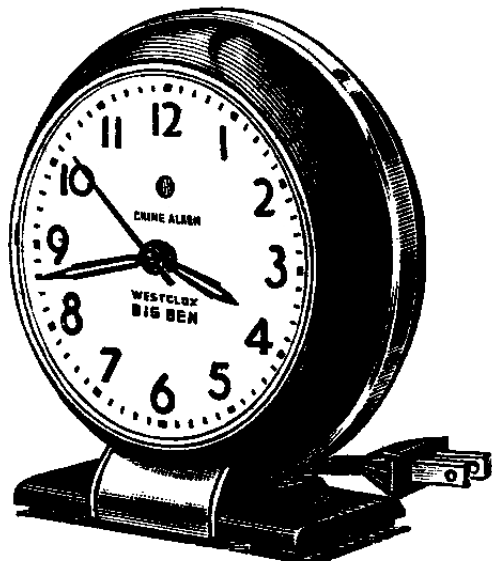

Style 5 Big Ben Electric

Introduced 1941, last shipped 7/42, discontinued 10/45. Ivory case, white dial with brown numerals or brown-banded luminous dial. Back labeled "S6-B", base labeled "69-C". Second hand behind hour hand. Height 5 5/8"

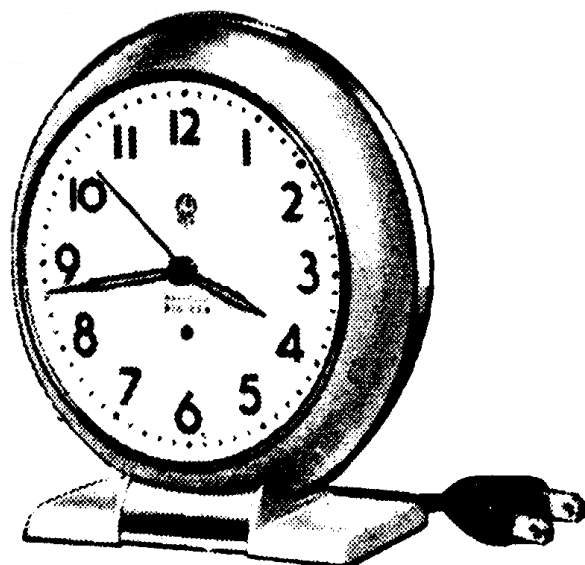

Style 5 Baby Ben Electric

Introduced 1940, last shipped 7/42, discontinued 1945. Ivory case, white dial with brown numerals or brown-banded luminous dial. Labeled “S-6” on base and “S 6” on back.

Height 4 3/16”. This clock is larger than the keywind Baby Ben style 5.

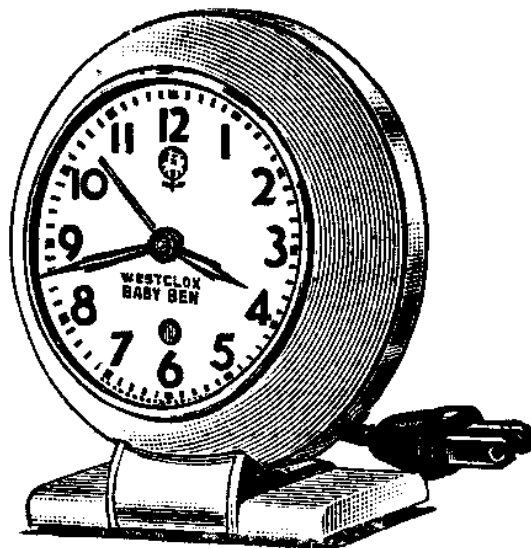

Model S6-D Big Ben Electric

This model has a brown Bakelite case labeled “S6-D” on back. Height 5 1/8”.

The motor runs the clock and winds the alarm mainspring. The plain dial model was introduced in December 1947,³⁵ and the luminous dial model was introduced in May 1948. Both models were last shipped in November 1952. Brown Bakelite case.

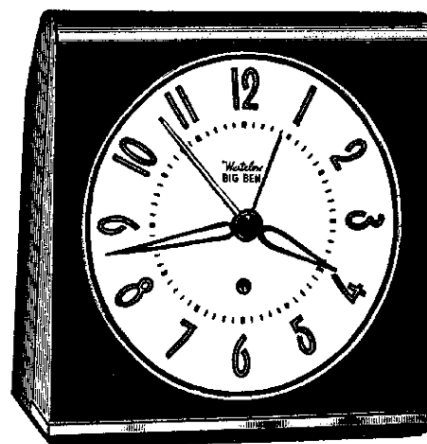

Style 7 Big Ben and Baby Ben Electric

Made from 1956 to 1964, these clocks use the Westclox M4, which was a more compact design than earlier motors, enabling the Baby Ben electric to be the same size as the keywind.

Baby Ben: 1956 – 1964. Back labeled “S10F”. Made in beige, light green, pink. Height 3 3/4”

Big Ben: 1956 – 1964, base labeled “75-102”, back labeled S10-D. Made in ivory or bronze cases. Height 4 7/8”



Style 8 Ben Electric

1964 – 1982. Medium size case (smaller than keywind Big Ben, bigger than Baby Ben). Some say “Ben Electric” and some say “Big Ben Dialite” above the center of the dial. The back is labeled “S12V” and the bases have several different numbers. Made in colors including avocado green, blue, and white. Height 4 1/4”.

These clocks use the M5 motor with sealed rotor unit which is detachable from the field coil.

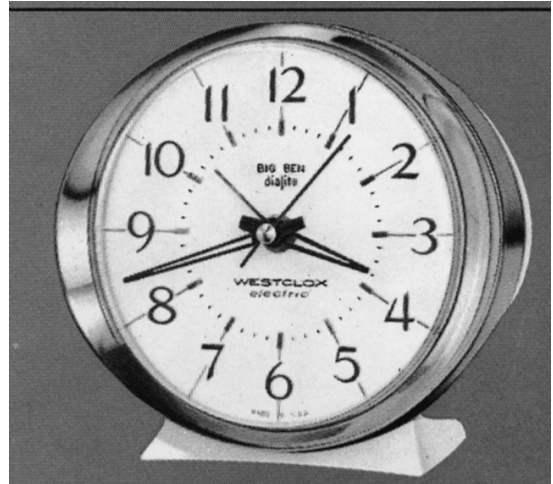

“**Big Ben Solid State**” was an LED readout digital alarm introduced in 1974 at a retail price of \$49.50.

OTHER BIG BEN AND BABY BEN MODELS

“**Big Ben Futura**” in spherical plastic case was introduced in 1973 and made through 1978³⁶.

“**Big Ben Futura Deluxe**” with silver tone metallic case was introduced in 1974 and made through 1981³⁷.

“**Baby Ben Day/Date**”, in the same style case as the Futura, was introduced in 1976 in a white case with red, blue or green dial; and a metallic silver case. In 1977, the metallic case model was renamed “**Baby Ben Day/Date Deluxe**” and two more models were introduced.

MODELS RELATED TO THE BIG BEN

Bingo: From 1914 – 1925 there was a nickel plated leg model clock called Bingo that was very similar to the Big Ben. Its movement is rear-mounting like the Big Ben style 1a, and the dial has numerals like the early Big Ben in figure 1.

Clock of Tomorrow: Made from 1955 to 1959, it was discussed on page 31.

MODELS RELATED TO THE BABY BEN

LaSalle or Dura Case These are often called “Dura Case” clocks because the Dura Company of Toledo, Ohio made the cases. These clocks have a nickel-plated die-cast case with a pewter like finish that Westclox called the “Butler” finish. They have a Baby Ben movement.

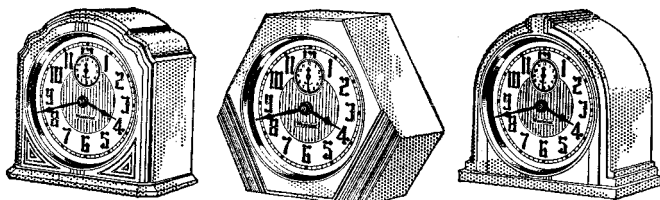

61-C, #401

61-F, #403

61-D, #402

**Non-luminous LaSalle (Dura Case)
series: 1930 - 1934**

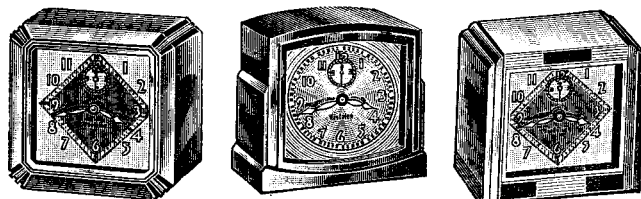

61-J, #406

61-G, #404

61-H, #405

**Luminous LaSalle (Dura Case)
series: 1931 - 1934**

LaSalle 61-Q

This model has an extremely convex glass and dial. It was introduced in 1935 in plain and luminous dials. The plain dial model was discontinued 12/37, and the luminous dial model was discontinued 2/38. It uses a Baby Ben movement.

This advertisement is from the 1935 Swartchild & Co. Catalog.

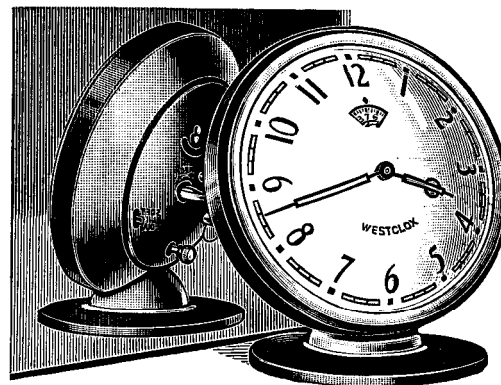

LA SALLE NEW

Thin model with many practical features. Finished in lustrous gunmetal with nickel trim . . . attractive silver plated dial . . . dust-proof movement. Quiet tick . . . loud or soft alarm. Substantial round base . . . felt cushioned underneath. Features a slight backward tilt which, together with the convex metal dial, plain numerals, and pierced hands, makes it especially easy to read. Height, 4½"; weight, 1¼ lbs.

No. **833341**. LaSalle, plain dial. Keystone List.....**\$5.54**

No. **833342**. LaSalle, luminous dial. Keystone List.....**\$6.94**

“Seth Thomas Baby Bens”

There were eight or more alarm clock models Marketed by Seth Thomas from the 1930's through the 1950's that use the Baby Ben movement. One example is shown below. More models can be seen on this web page:

<http://clockhistory.com/westclox/products/ben/sthomas/index.html>

This “Seth Thomas Baby Ben” model has a Catalin plastic case and was made in the late 1940's and early 1950's. Photo from advertisement for Catalin Corporation of America, ca. 1950.

The color of the Catalin plastic case is black with yellowish streaks in it. The example in my collection is dated 12-46 (December 1946) on the movement.



Royal Jewel

The Royal Jewel alarm clock is 3 3/16 inches tall and has a 2 5/16 inch dial. The case is die cast with ivory color paint. It uses the same movement as a Baby Ben alarm clock. My example is dated 2-2-40 (February 2, 1940) on the movement. Pat Dowd has reported an example dated 12-8-39, and Greg Adams has reported examples dated 9-30-38 and 3-3-39.

The Royal Jewel was made by Westclox for the Jewel Tea Company, Inc. of Barrington, Illinois. The 1940 “Jewel News” offers the Royal Jewel for sale, along with many other household items. You may see more details on this web page:

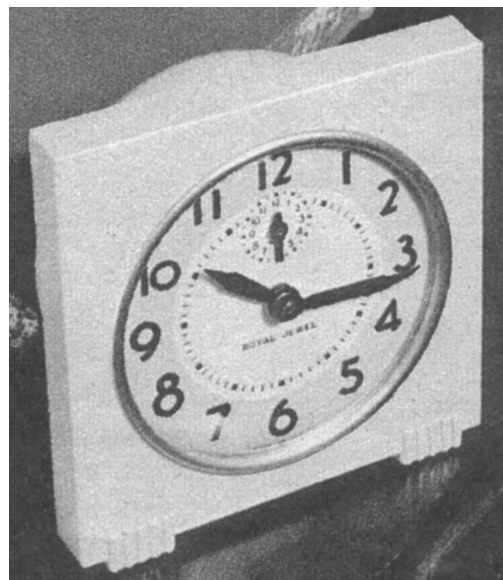

http://clockhistory.com/westclox/unusual/royal_jewel/index.htm

REPRODUCTION MODELS OF BIG BEN AND BABY BEN

Miniatures of styles 2, 5 and 7 with quartz movements were introduced in 1997, with only 5,000 of each style made.³⁸

Several quartz movement clocks with the name “Big Ben” on the dial have been available for several years. These are not traditional Big Ben designs, but Salton, Inc. is making big use of the “Big Ben” trademark. One notable example is the reproduction of the 1949 Moonbeam flashing light alarm clock. The dial is labeled “Big Ben” “Moonbeam”.

Style 1a Reproductions: Westclox made an excellent, almost exact, reproduction of the style 1a Big Ben in 1970.³⁹ Most are in nickel finish cases, but some were made in gold plated cases.

They can be identified by having the modern type of flat head screws with shoulders instead of round head screws, and the following patent dates at the upper right of the back:

PATENTED
JUNE 9, 1908
NOV. 17, 1908
DEC. 15, 1908
MAY 24, 1910

They were sold in a very attractive hexagonal box which has pictures of antique items on the sides (tricycle, telephone, carriage, etc.) The movement is a windup almost identical to the original.

Style 2 Reproductions: A miniature of the style 2 was made in 1997, as mentioned above. It has a quartz movement.

Style 3 Reproductions: A style 3 Big Ben with a quartz movement was introduced in the late 1990’s (please tell me if you know the year of introduction). The reproduction can be identified by having a sweep alarm indicator (instead of having the alarm indicator in a sub-dial below the numeral “12”). Also it has a battery compartment instead of two winding keys.

Style 5 Reproductions: A style 5 Big Ben with a quartz movement was introduced in the late 1990’s (please tell me if you know the year of introduction). The reproduction can be identified by having a sweep alarm indicator (instead of having the alarm indicator in a sub-dial below the numeral “12”). Also it has a battery compartment instead of two winding keys. It was available in an all chrome case (the originals always have a painted case).

A miniature of the style 5 was made in 1997, as mentioned above. It has a quartz movement.

Style 6 Reproductions: A style 6 Big Ben with a quartz movement was introduced in the early 2000’s (please tell me if you know the year of introduction). The reproduction can be identified by having a sweep alarm indicator (instead of having the alarm indicator in a sub-dial below the numeral “12”). Also it has a battery compartment instead of two winding keys.

Clock of Tomorrow Reproductions: A Clock of Tomorrow with a quartz movement was introduced ca. 2008 (please tell me if you know the year of introduction). The reproduction can be identified by having a battery compartment instead of two winding keys. Also, the dial says “Big Ben” and “Clock of Tomorrow” whereas the original did not say “Big Ben” on the dial.

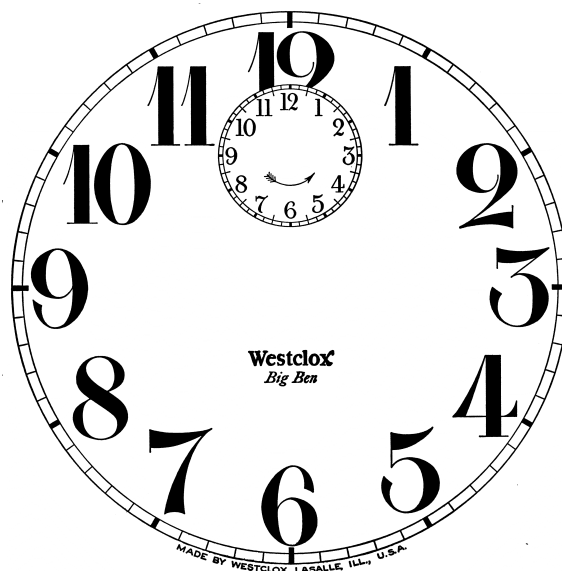

Figure 30 Showing the dial used on the reproduction of the Big Ben style 1a. Note especially the lettering at the bottom.

Style 7 Reproductions: The style 7 was revived for a time during the style 8 era (1964 – 1981). It was a windup alarm clock. Please let me know if you have any details.

A miniature of the style 7 was made in 1997, as mentioned above. It has a quartz movement.

Style 8 Reproductions: Since around 2006, key wind reproductions of the style 8 Big Ben and Baby Ben have been available. They can be identified because they are made in China, not USA. These clocks have a plastic back and an internal alarm bell.

Dura Case Reproductions: A quartz reproduction of the model 61-G (the curved case top model with luminous dial) was introduced ca. 2008. It is called the “Athens” and can be identified from the front by having an alarm setting disc which rotates behind the dial. Also it says “Big Ben” on the dial.

WESTCLOX PATENTS FOR SPRING DRIVEN CLOCKS

Date Granted	Patent Number	Date Filed	Title	Summary	Patentee
Sept. 22, 1885	326,602	June 1, 1885	Manufacture of Clock Works	The basic Westclox lead alloy casting process	Charles Stahlberg
Jan. 4, 1887	355,624	Aug. 7, 1886	Manufacture of Shafts and Pinions For Clock works	Casting machine for wheel-pinion assemblies	Charles Stahlberg
Oct. 28, 1902	712,325	June 18, 1902	Lantern Pinion	Westclox type wheel-pinion assembly	Andrew H. Neureuther
May 15, 1906	820,794	Aug. 19, 1905	Barrel Click Spring for Timepieces	The double-ended click spring between the plate and the barrel.	Joseph Klein
June 4, 1907	855,775	May 21, 1906	Repeating alarm Clock	Basic idea of the intermittent alarm	William S. Hawthorne
Oct. 8, 1907	867,834	Dec. 28, 1906	Disk Feeding Machine	Feeds thin washers from a stack one by one to another machine	Andrew H. Neureuther
May 19, 1908	887,835	July 8, 1903	Mechanical Movement	For use in production machinery	Andrew H. Neureuther
June 9, 1908	890,066	Jan. 6, 1908	Alarm Clock	Basic idea for the bell back Big Ben case	George Kern
Nov. 17, 1908	904,333	July 1, 1908	Alarm Clock	Big Ben movement	George Kern
Dec. 15, 1908	906,915	Oct. 23, 1908	Lantern Pinion	Improvement on # 712,325	Andrew H. Neureuther
Oct. 19, 1909	937,259	May 21, 1907	Automatic Pinion Cutting Machine	Pinion blanks are put in, and are automatically cut with a milling cutter.	Andrew H. Neureuther
April 5, 1910	953,752	Oct. 8, 1908	Automatic Pinion Cutting Machine	Pinion blanks are put in, and are automatically cut with a milling cutter.	Andrew H. Neureuther
April 5, 1910	953,753	Oct. 17, 1908	Automatic Pinion Cutting Machine	Pinion blanks are put in, and are automatically cut with a milling cutter.	Andrew H. Neureuther
May 24, 1910	958,930	Sept. 27, 1909	Alarm Clock	Improvement of #904,333	George Kern
July 16, 1912	1,033,020	May 31, 1911	Clock Spring Barrel	Going barrel with easily removed cover (bayonet mount)	George Kern
Sept. 23, 1913	1,073,608	June 29, 1911	Clock	Clock case in which it is easy to withdraw the movement, by loosening the pendant and legs	George Kern
Nov. 18, 1913	1,078,858	Oct. 21, 1912	Alarm Clock	Rotary hammer alarm clock	George Kern
Feb. 10, 1914	1,086,719	Jan. 13, 1912	Clock	Removable bridge and retainer for Big Ben alarm mainspring for Big Ben alarm mainspring	George Kern
March 10, 1914	1,089,648	Aug. 16, 1913	Alarm Clock	Alarm clock with 2 concentric bells	George Kern

Date Granted	Patent Number	Date Filed	Title	Summary	Patentee
May 12, 1914	1,096,542	Dec. 16, 1912	Automatic Set for Alarm Clocks	Alarm mechanism which will sound every 24 hours, particularly applicable to 8-day alarms	George Kern
May 2, 1916	1,181,557	Jan. 24, 1916	Alarm Clock	Alarm mechanism that shuts off after predetermined period. Uses worm gear. (Westclox 8 day alarm ca. 1930)	Frank X. Wehrle (Seth Thomas)
April 15, 1919	1,300,278	Feb. 27, 1918	Alarm Clock	The Big Ben style 1A case	George Kern
Nov. 9, 1920	1,358,457	June 15, 1920	Winding Key For Clocks	The flattened key used on Baby Ben	Norman T. Mills
Dec. 1, 1925	1,563,431	Dec. 17, 1923	Machine for Manufacturing and Mounting Pinions and Wheels	11 sheets of drawings	Andrew H. Neureuther
April 16, 1929	1,709,146	Dec. 17, 1923	Machine for Manufacturing and Mounting Pinions and Wheels	11 sheets of drawings	Andrew H. Neureuther
Feb. 17, 1931	1,793,333	July 31, 1925	Apparatus for Timing Clocks And Watches	A device which impulses a balance wheel with hairspring and compares its rate with hairspring and compares its rate of vibration to a standard	Erich Maier
March 8, 1932	1,848,520	Sept. 1, 1927	Movement Checking Machine	Machine using a beam of light for checking rate of clocks and watches	William Barton Eddison
May 17, 1932	1,858,563	Aug. 29, 1930	Alarm Clock	Big Ben Chime alarm movement	Max Schlenker
May 24, 1932	1,860,153	April 6, 1929	Micrometer Adjusting Device For Clocks and Similar Mechanisms	Micrometer clock regulator	Andrew H. Neureuther
Oct. 24, 1933	1,932,184	Jan. 21, 1932	Alarm Clock	A Chime alarm movement in which the quieter alarm will always sound before the louder alarm, regardless of how far wound up the alarm mainspring is	Max Schlenker
July 24, 1934	1,967,995	July 3, 1933	Alarm Clock	An alarm first sounds for a short interval and automatically shuts off, after a definite period it rings again until the sleeper arises and shuts it off.	Max Schlenker
Sept. 15, 1936	2,054,449	Dec. 28, 1934	Flexible Shutter and Method Of Making Same	The shutter used in the Travalarm	Irving Florman

Date Granted	Patent Number	Date Filed	Title	Summary	Patentee
Oct. 17, 1944	2,360,589	Sept. 4, 1943	Alarm Clock	A cheaper version of the model 66 movement in which the alarm hammer is integral with the shut off arbor and the hammer strikes an extension of the trip spring.	Max Schlenker
Oct. 24, 1944	2,361,128	April 12, 1943	Clock	Movement of "Clock of Tomorrow"	Max Schlenker

WESTCLOX DESIGN PATENTS FOR BIG AND BABY BEN AND RELATED CLOCKS

Date Granted	Patent Number	Date Filed	Title	Summary	Patentee
Aug. 29, 1911	Des. 41,725	Nov. 7, 1910	Casing for Alarm Clocks	Style 1 Big and Baby Ben	George Kern
Mar. 29, 1927	Des. 72,332	Feb. 24, 1926	Clock Case	Style 2 Big and Baby Ben	Henry A. Schierholtz
Mar. 4, 1930	Des. 80,613	Nov. 18, 1929	Clock Case	61-D Dura Case (LaSalle)	Dura Company
Mar. 4, 1930	Des. 80,614	Nov. 18, 1929	Clock Case	61-C Dura Case (LaSalle)	Dura Company
Mar. 4, 1930	Des. 80,615	Nov. 18, 1929	Clock Case	61-F Dura Case (LaSalle)	Dura Company
Sept. 2, 1930	Des. 81,927	April 28, 1930	Clock Case	61-H Dura Case (LaSalle)	Dura Company
Sept. 9, 1930	Des. 81,975	April 28, 1930	Clock Case	61-G Dura Case (LaSalle)	Dura Company
Aug. 18, 1931	Des. 84,890	April 28, 1930	Clock Case	61-J Dura Case (LaSalle)	Dura Company
Sept. 15, 1931	Des. 85,099	May 21, 1931	Clock Case	Big Ben Electric model 820 & 830	Martin H. Kaefer
Jan. 5, 1932	Des. 85,916	April 20, 1931	Clock Case	Style 3 Big and Baby Ben	Henry Dreyfuss
Oct. 2, 1934	Des. 93,522	June 29, 1934	Clock Case	61-Q case (LaSalle)	Max Schlenker
Apr. 11, 1939	Des. 114,262	Nov. 19, 1938	Clock Case	Style 5 Big and Baby Ben	Henry Dreyfuss
Aug. 30, 1949	Des. 154,995	Jan. 8, 1947	Clock	S6-D (The square brown Bakelite electric Big Ben)	Henry Dreyfuss
Mar. 20, 1951	Des. 162,523	Sept. 8, 1949	Clock	Clock of Tomorrow	Ellworth R. Danz
Aug. 10, 1965	Des. 201,895	Feb. 19, 1964	Clock	Style 8 Big and Baby Ben	Ellworth R. Danz
Sept. 30, 1980	Des. 257,129	Feb. 10, 1978	Clock	Style 9 Big and Baby Ben	Ellworth R. Danz

ACKNOWLEDGEMENTS

I would like to thank Jeff Wood for his extensive research, and assistance with proofreading and organizing. Many thanks to Dennis Sagvold, who provided the oldest Big Ben we have examined (figure 1); Greg Adams for providing figures 2, 10 and 12 – 16, and John Darrow for the clock shown in figure 9. The following individuals have provided much help over the years: Steve Berger, Dana Blackwell, Emmett Buchanan, John Darrow, Pat Dowd, Bernard Edwards, Steve Fitzsimmons, Elmer Finken, Leslie Hoin, Frank Kearly Jr., Robert McNichol, Frank Nyilas, Robert Schug, Lee Werling Jr., James Whitaker, Nelson Winslow and G. Lee Wilson. We thank the following organizations for information and assistance: American Clock and Watch Museum, National Association of Watch and Clock Collectors, and the Regional History Center at Northern Illinois University, DeKalb, Illinois. Many collectors have graciously shared information with us, and we thank every one and ask forgiveness for any names omitted here.

We offer special thanks to Ellworth Danz, Ed Cielasyzk and Max Schlenker, formerly of Westclox.

We thank the following individuals for proofreading and making many helpful suggestions: Gary Biolchini, Ellworth Danz, Jim Galazka, Leslie Hoin, John Klyce, Penny Marsh, Lee Werling Jr., James Whitaker and Jeff Wood.

This article started out as a handout accompanying the Westclox display at the 1984 National Convention of the National Association of Watch and Clock Collectors in Indianapolis, Indiana. We think the following contributors to the Westclox display: Steve Berger, Emmett Buchanan, John Darrow, and Dana Blackwell and the American Clock and Watch Museum of Bristol, Connecticut. I give special thanks to Emmett Buchanan for his friendship and major contribution to the display.

RECOMMENDED READING

Westclox, An Identification and Price Guide, Gary Biolchini, Schiffer Publishing, 2003.

Westclox: Wind-up, Jim Linz, Schiffer Publishing, 2004.

Legged Alarm Clocks, Dennis Sagvold, Schiffer Publishing, 2004.

ClockHistory.com web site: <http://clockhistory.com/westclox/>

Vintage Westclox web site: <http://www.vintagewestclox.com/>

For more references see ClockHistory.com at:

<http://clockhistory.com/westclox/other/references/index.html>

United States Patents: You may now view and print patents from Google Patents at http://www.google.com/advanced_patent_search. You may enter a patent number in the patent number field. For a design patent, enter a “D” prefix (e.g., to view patent Des. 81,975, enter D81975). Years ago I had to order patents by mail for several dollars each, and the copy quality was often poor. These patents from Google may be downloaded as a PDF file and printed, and the quality is very good. You may search for patents in several ways including inventor, patentee, date, and keywords.

WARNING!

Most older clocks and watches with luminous dials contain radium, a hazardous radioactive substance proven to cause cancer, and which produces radon gas. Careless handling of luminous materials releases microscopic particles into the atmosphere, where they may be inhaled and become lodged in the lungs. In addition, flaking of luminous paint, with fragments remaining within the clock, is commonplace. Under NO CIRCUMSTANCES should children be permitted to play with, or take apart, luminous timepieces.

¹ Big Ben style 1 has a round pendant, whereas Baby Ben had an oval pendant until ca. 1926 – 1927. The numeral 4 differs slightly between the two clocks.

² *It's Like This: The Story of George Kern*, John Barron, LaSalle-Peru Daily News, reprinted in *The Coin Slot*.

³ *Westclox Department Reports, 1904 - 1922*, Collection 116, Box 7, Files 3 - 14, held by the Regional History Center at Northern Illinois University, DeKalb, Illinois.

⁴ *National association of Watch and Clock Collectors (NAWCC) Bulletin*, whole # 271, August 1991, p.466. "The Answer Box".

⁵ *Westclox Tick Talk* (Westclox company publication), Nov. 1914; and John Barron, *LaSalle-Peru Daily News*, July 1981.

⁶ *A Plan for a National Advertising Campaign*

On Alarm Clocks, submitted to the board of directors of The Western Clock Manufacturing Company, March 16, 1908, attributed to Gaston A. LeRoy. This document may be viewed on the ClockHistory.com web site at

<http://clockhistory.com/westclox/company/documents/leroy1908.htm>

⁷ *Big Ben, The National Alarm, Nineteen Twelve*, Westclox advertising material copyright 1911 by the Western Clock Mfg. Co. and signed G. A. LeRoy. Reprinted from the horological library of Bernard J. Edwards.

⁸ *Saturday Evening Post*, March 21, 1914, Advertisement on p. 33.

⁹ *Big Ben, The National Alarm, Nineteen Twelve*

¹⁰ *Ibid.*

¹¹ The latest BIG BEN style 1 we have examined has a movement dated 7-24-18. The earliest style 1a we have seen has a movement dated 7-9-18, showing a time overlap between these models. A resolution was presented to management requesting that the new model BIG BEN be put into production. This resolution followed a November 27, 1917 Sales committee meeting at which the new style BIG BEN was presented, and is dated December 4, 1917.

¹² *A Plan for a National Advertising Campaign*

On Alarm Clocks.

¹³ The movement and more details may be seen on the ClockHistory.com web site at http://clockhistory.com/westclox/products/ben/baby_pred/index.html

¹⁴ *Westclox Department Reports, 1904 - 1922.*

¹⁵ *Ibid.*

-
- ¹⁶ *Jeffrey Wood*, Wilbraham, Mass., personal correspondence. We are indebted to Jeff for his detailed research on the evolution of the early baby Ben. More information can be seen on the clockHistory.com web site at http://clockhistory.com/westclox/products/ben/style1/baby_dates.htm
- ¹⁷ *Ellworth Danz*, former Chief Stylist at Westclox, personal communication.
- ¹⁸ *Westclox Tick Talk*, June 20 and July 5, 1931.
- ¹⁹ *Westclox Tick Talk*, December 1932, p. 9.
- ²⁰ *Westclox Tick Talk*, February 1933, p. 7.
- ²¹ *Ibid.*
- ²² *Westclox Tick Talk*, April 1936, p. 18.
- ²³ *Westclox Price Change Book* in the possession of Ellworth Danz.
- ²⁴ *Henry Dreyfuss, Industrial Designer: The Man in the Brown Suit*, Russell Flinchum, Rizzoli International Publications, 1997.
- ²⁵ *Alarm Clock Newsletter*, publication of The Howard Banta Alarm Clock Chapter #178, 3rd quarter 2001, vol. 2 Issue 2, p. 8.
- ²⁶ *Ellworth Danz*, personal communication.
- ²⁷ *Ibid.*
- ²⁸ *Ibid.*
- ²⁹ *Ibid.*
- ³⁰ *Ibid.*
- ³¹ *Ibid.*
- ³² *Ibid.*
- ³³ Westclox and Seth Thomas catalog, 1990
- ³⁴ *Westclox Tick Talk*, August 20, 1931, p. 1
- ³⁵ *Westclox Tick Talk*, December 1947, p. 24
- ³⁶ *Ellworth Danz*, personal communication.
- ³⁷ *Ellworth Danz*, personal communication.
- ³⁸ *Horological Times* (publication of American Watchmakers-Clockmakers Institute), October 1997, p. 40.
- ³⁹ *NAWCC Bulletin*, whole # 271, August 1991, p.466.